

plocha skladů,
transformační
plocha



pevná plocha



návrh



zelená plocha

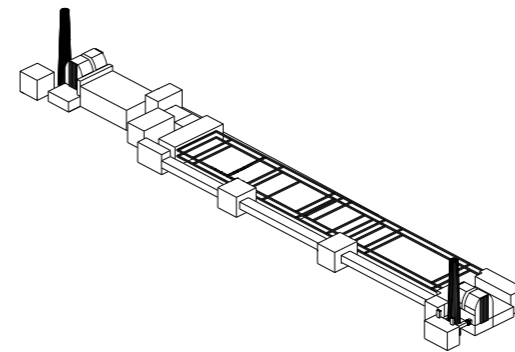

O_aglomerace
TŽ

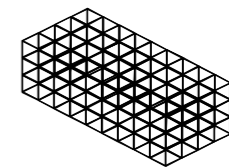

F_pavilony_ocelové konstrukce ve veřejném prostoru s různou náplní umístěny po celém areálu

A_administrativa

A_administrativa

A_administrativa

A_administrativa

S_tribuna

S_sportoviště

P_parkovací dům

B_studentské koleje

P_parkovací dům

V_vývojové centrum

T_tecnologické haly

U_univerzita

V_vývojové centrum

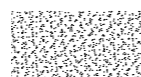

pevná plocha



návrh



zelená plocha

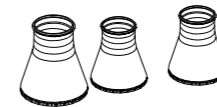

O_chladicí věže

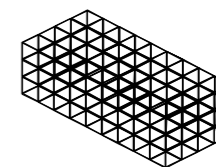

F_pavilony_ocelové konstrukce ve veřejném prostoru s různou náplní umístěny po celém areálu

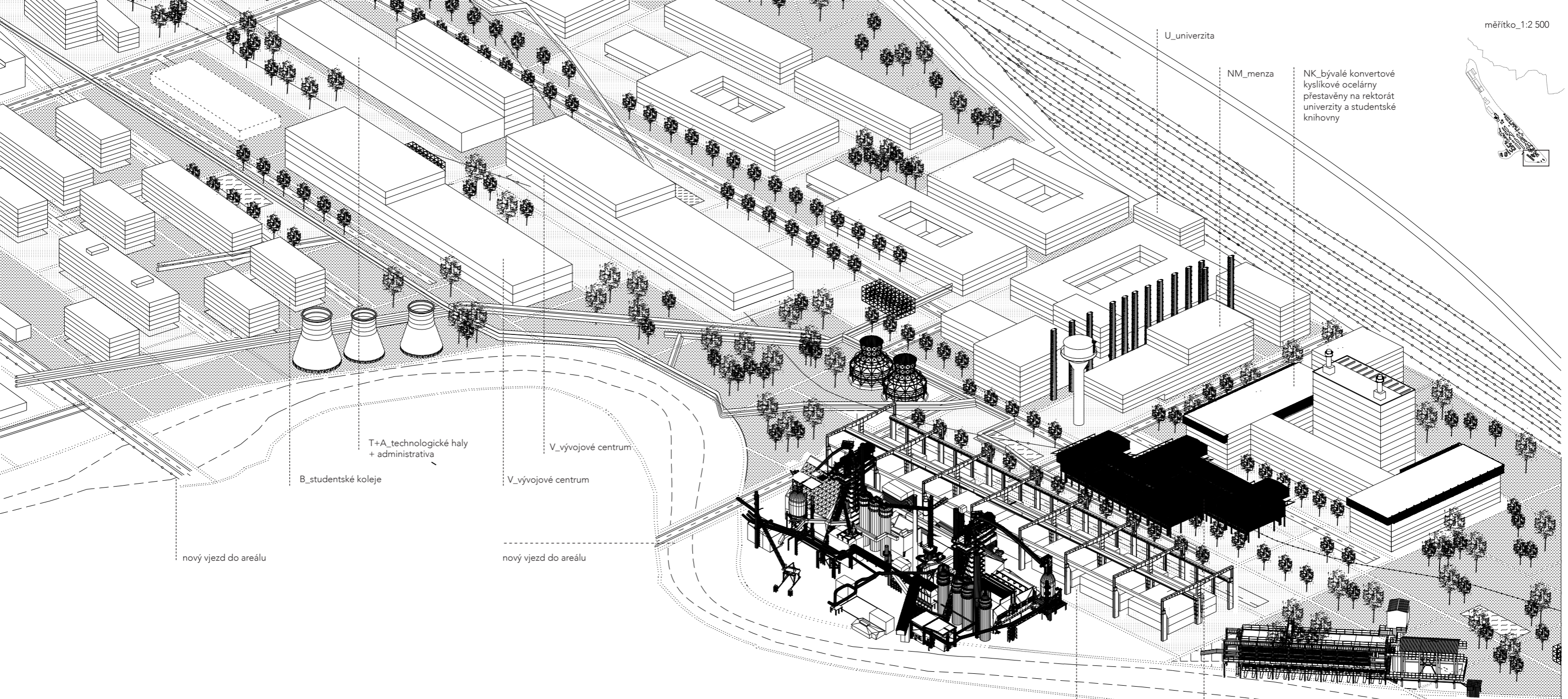

U_univerzita

NM_menza

NK_bývalé konvertové
kyslíkové ocelárny
přestavěny na rektorát
univerzity a studentské
knihovny

T+A_tecnologické haly
+ administrativa

V_vývojové centrum

B_studentské koleje

V_vývojové centrum

nový vjezd do areálu

nový vjezd do areálu

ND_bývalá ocelárna
--> obchody, kavárny,
obslužnost

NS_bývalé sklady přetavěny na studentský

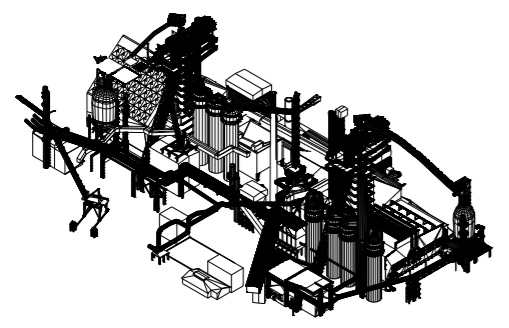

O_vysoké pece

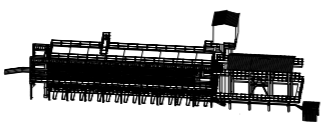

O_granulové
zásobníky

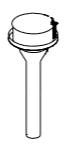

O_vodojem



O_chladicí věže

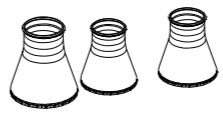

O_chladicí věže



zelená plocha



pevná plocha

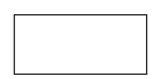

návrh