

TO6B

Diploma thesis

Summer semester 2024

Faculty of architecture CTU in Prague

Author _ Eliška Kořínková

Supervisor _ doc. Ing. arch. Dalibor Hlaváček, Ph.D.

pa-ne-ly

Beton, výztuž,
spoj a 3,6 metru.
Stěna v příčném směru.
Odolnost vůči větru.

Okno, okno, balkon.
A zas a zas a zas
tvoří fasády pás.
A všude panely!
Takhle jste to nechtěli?

Hlavně světlo v obýváku
a výhledy do přírody.
Větší koupelnu byste si přáli?
Místo ve skříni
a líp řešenou kuchyni?

Příjemný prostor pro bydlení.
Místo, kde si vypít kávu,
z herny vyběhnout na trávu.
A usmát se na souseda od vedle.

Okno, zimní zahrada, okno, balkon.
Taky vstup, co najdeš snáz
tvoří fasády pás.
A všechno to jsou panely.
To jsme tu dlouho neměli...

Prostory pro volný čas,
i kousek ráje co je jenom váš.
Přes společné záhonky
až po slunné garsonky,
sdílené bydlení a všechno mezi tím.

Tvořím,
v domě co tady už stál.
Jen trochu jiný má teď tvar.
Tak pojd'te dál!

- 1. Introduction**
- 2. History of prefabricated housing buildings**
- 3. Czech panel systems development**
- 4. System T06B**
- 5. Proposals**
- 6. Application**
- 7. Conclusion**
- 8. Sources**

0. Content

1.

Introduction



1.

Introduction

Housing is one of the basic needs of a human being. Our ancestors sought safe refuge in all stages of development, and it has been a topic addressed by every historical civilization. With respect to historical context, the requirements for housing and the space we call “home” have changed significantly as people’s needs evolved and as their position in society changed.

The way we perceive housing today reflects contemporary society. To grasp this issue, it is necessary to examine the trends that have led to the current situation and the way of life we lead today. Housing is influenced not only by the size of families, the hierarchical relationships developed among relatives, or the relationships people form outside their family circle, but also by the mode of communication, job opportunities, and much subtler factors stemming from different understandings of the world. With the growth of communication technologies, our demands for the space around us are changing significantly. A single desk with a computer enables us to reach the opposite end of the world in a matter of seconds. An increasing number of people are realizing the overload of material possessions and are moving towards reducing material things. These realities further prescribe the requirements for a home and its form. Rather than a clear definition of what housing should entail, it is pertinent to seek answers to questions about what activities should take place at “home” and what “home” should provide us with.

These activities will vary greatly depending on the place where the people for whom we create “home” live. Different communities develop at different rates; thus, they have different requirements.

Drawing inspiration from abroad and applying certain elements in a different environment can enrich society. However, the need to consider local conditions and the setting of a specific society is crucial in housing design or interventions.

Alongside rapid changes and increasingly advanced technologies, there are growing demands for the space around us and the planet. Climate change and associated problems are certainly not the subject of this work. However, it is important to acknowledge the huge impact of construction on energy consumption, resources, and the waste associated with new construction. A way to slow down and mitigate the negative impacts of construction on the environment in which we live could be the effort to use existing buildings and transform them to meet contemporary demands and the needs of inhabitants.

Panel buildings are a controversial phenomenon on which Czech society is divided into two camps with completely opposing views. Many debates and publications are burdened with the opinions of their authors, who lean towards one extreme or the other. However, if we remove emotions and overlook the historical context in which panel buildings were created, it is possible to view them as a set of buildings with similar characteristics in which nearly a third of Czech citizens live.

This work aims to explore the historical trends that led to the emergence of this type of housing, namely panel buildings themselves. It seeks to find the developmental line of individual systems and, given the scope of the entire topic, to dissect a specific system that was developed in the territory of the former Czechoslovakia. The T06B system is the most widespread system used in our country. Examples of it can be found in all regions of the Czech Republic. It thus represents a wide range of buildings with very similar parameters from which we can draw. Insights from this work will be used to create a comprehensive picture of the given system and will serve as a theoretical basis for forming concepts of possible inputs into the system being addressed and thus the future use of buildings of this type...



Private villas, panel house "T06B" and laundry in the Františkov housing estate in Liberec, late 1970s!

2. History of prefabricated housing buildings

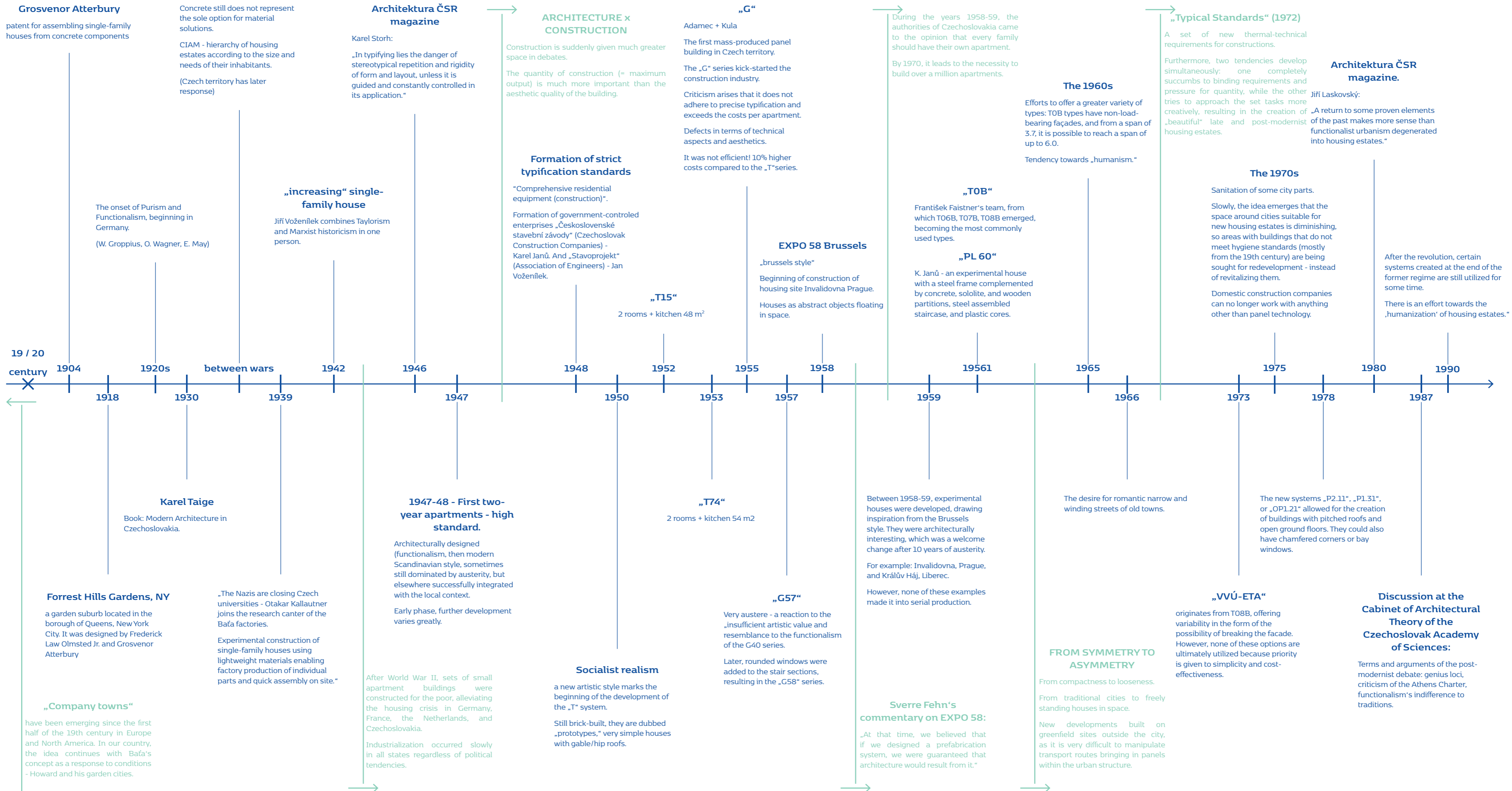

2.

History of prefabricated housing buildings

Even though we currently understand the issue of panel housing estates mainly as a phenomenon arising after World War II, its history dates to the first half of the nineteenth century. The emergence of panel buildings and housing estates was influenced by events and society long before the First and Second World Wars and the resulting housing shortages. The rise of panel buildings was shaped by countless factors, societal moods, technological progress, and influential individuals not limited to architects and urban planners.

Housing became a burning issue during the Industrial Revolution. We can trace the tendencies and arguments justifying the construction of panel housing estates as an alternative to poor housing conditions in historic buildings. At that time the problems of housing were undeniable, and it is evident that they needed to be addressed. Grim hygienic conditions, minimal space, the density of residential neighbourhoods, and their location within the city led to heated debates and many utopian visions. With the increasing number of people employed in the industrial sector, urban overcrowding occurs, which cities are not prepared for. Industrial companies were interested in accommodating workers near factories and therefore came up with the idea of “company towns”, which began to emerge in the first half of the 19th century.¹ They involved accommodations for workers in company-built housing, in brand new villages near the company. These workers’ settlements often arise haphazardly, and the first problems in urban design appear in the planning of newly built residential neighbourhoods.

Several theorists and architects reacted to

¹ STR. 28, Paneláci 2 - Skřivánková, Švácha, Novotná, Jirkalová

the development of housing associated with industrialization. For example, Ebenezer Howard succeeds in clearly formulating ideas based on his observations and the work of his predecessors and teacher Robert Owen.² Howard came up with the idea of the Garden City, which addresses not only the issue of poor hygiene conditions in contemporary cities but also aims to combine the advantages of the village and the city and provide comfortable conditions for the residents. It stipulates, among other things, the size of individual urban clusters, the organization of areas for living, industry, and recreation, the integration of nature, and the transportation system.³

Later in the Czech Lands, a pioneer of workers’ colonies was Tomas Bata, who was particularly active in Zlín. Initially, he built neighbourhoods of family houses for his employees. Later, he switched to smaller apartment buildings that used early prefabrication and were being built with one of the first panel components.

Here, we must mention two tendencies that significantly shaped opinions at the turn of the nineteenth and twentieth centuries and stimulated discussion and trends toward industrializing construction. These are Taylorism and Historicism.⁴ Taylorism emerged during the Industrial Revolution as an attempt to maximize production efficiency. It was inspired by factories and mass production, and it gradually entered construction. The idea behind it was efficiency,⁵ “A brick is too small,” so building with

² (HOWARD, Ebenezer. *Garden Cities of To-Morrow: Urban Planning. 1.* Createspace Independent Publishing Platform, 2016. ISBN 1537406507.)

³ (HRŮZA, Jiří a ZAJÍC, Josef. *Vývoj urbanismu II.* Praha: ČVUT, 1996. ISBN 80-01-01549-1.)

⁴ STR. 54, Paneláci 1 - Skřivánková, Švácha, Novotná, Jirkalová

⁵ (Taylorismus. CoJeCo [online]. 2024, 1999-2024 [cit. 2024-01-13]. Dostupné z: <https://www.cojeco.cz/taylorismus>)

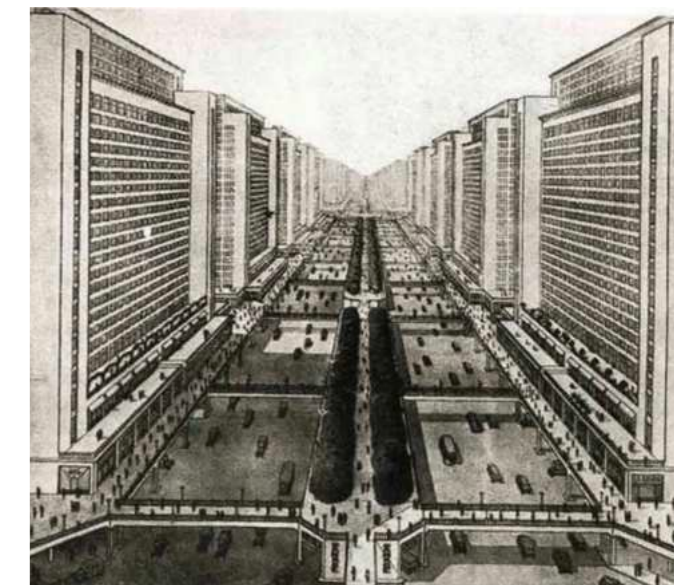

An example of the functional zoning of modernist urbanism⁴

2.

it is ineffective and expensive. This prompts the first thoughts about prefabricated panel production.

Historicism, in this case, is based on the belief that it is necessary to “go with the times”⁶ to keep in touch with the latest trends and technical knowledge and apply these in all fields. The fact that everything was being manufactured in factories must also lead to the industrialization of construction.

All this led to numerous experiments and a gradual effort to transfer the production of certain construction elements into a factory environment. Many were exploring the possibilities of using new materials and methods. In 1904, Grosvenor Atterbury obtained a patent for the assembly of family houses from concrete components, thus becoming one of the first

⁶ STR. 56 Paneláci 1 - Skřivánkova, Švácha, Novotná, Jirkalová



Houses for the poor in Brno, architect Josef Polášek¹¹

architects to start using prefabricated components in his designs.⁷

World War I put pressure on construction, especially in housing development. People turn back to Howard's Garden City theories and look for housing options in nature. However, many projects of neighbourhoods using this concept face numerous problems and become excluded areas, mainly due to a misunderstanding of the original idea and its incorrect adaptation to the needs of the time's inhabitants and cities. However, the pressure to build housing is so great that opposite trends and counterweights begin to emerge. The beginning of a new view of architecture can be traced back to Germany, where a new style called Purism began to emerge in the 1920s. Its main representatives are

⁷ STR. 59, Paneláci 1 - Skřivánkova, Švácha, Novotná, Jirkalová

Walter Gropius, Otto Wagner, and Ernst May. These theories led to the abandonment of ornament in architecture and the pursuit of purity and details that demonstrate functionality.

The frequency of the use of concrete is increasing, but it still does not represent the only material option. The CIAM group was formed, during the interwar period, with Le Corbusier as a leading figure. The group holds conferences and leads debates on the state and possible development of contemporary urbanism. The key idea is the city zoning and the hierarchization of settlements according to their size and the needs of their inhabitants. The principles were formulated and accepted at the fourth CIAM conference in 1933 and later called the Athens Charter.⁸ This document significantly influences the development of urbanism in the following decades.

Karel Taige is an eminent theorist who published one of his most important books, “Modern Architecture in Czechoslovakia,” in 1930. He had a fundamental influence on shaping architectural tendencies during and especially after World War II. Responses to developments in the rest of Europe come to Czechoslovakia with some delay. The year 1939 brings the closure of Czech universities, leading architect Otakar Kallautner to the research centre of the Bata factories. There we can find the first experiments with the family house structure built with lightweight materials, factory production of individual parts, and fast on-site assembly. These experiments developed during World War II and expanded beyond the borders of the Bata factories.⁹ In 1942, architect Jiří Voženílek created a project for a growing family house that combined the principles of Taylorism and Marxist historicism.

The housing situation after World War II is critical. Many people across Europe find themselves in very unsatisfactory conditions, and a rapid solution is needed again. Newly emerging residential buildings/ neighbourhoods are now largely influenced by insights from the interwar period and the ideas of the CIAM group. In Germany, the Netherlands, France, and Czechoslovakia, the housing crisis is initially mitigated by the construction of complexes of small apartment buildings for the poor. The situation encourages the industrialization of construction in all states, regardless of political tendencies.

In Czechoslovakia, communist tendencies are increasingly promoted in politics, leading to the popularity of standardized construction and the promotion of industrially manufactured building

⁸ MUSIL, Jiří. *Urbanismus* [online]. 2017. <https://encyklopedie.soc.cas.cz/w/Urbanismus> [cit. 2024-01-13].

⁹ STR. 14, Paneláci 2 - Skřivánkova, Švácha, Novotná, Jirkalová



Housing estate from the early sixties in České Budějovice¹⁰

components. The need to provide suitable housing for as many people as possible in the shortest possible time is emphasized. And if all apartments are the same, the differences between the various layers of the population will be erased. Propaganda is on the rise in many industries, not just in construction. However, there are already cautious voices warning about the issue of standardization. An example is the statement by Karel Stoh in the magazine *Architektura ČSR*, which points out that “standardization carries the danger of stereotypical repetition and rigidity of form and layout unless it is controlled and constantly monitored in its use.” (Karel Stoh, *Architektura ČSR* magazine, 1946)

The popularity of the Communist Party continues to grow, along with its influence on the shape of construction and architecture. Between 1947 and 1948, the first two-year plan is implemented, during which the first standardized apartment buildings are constructed. These are early examples of government-built apartments of fairly high standards. The buildings were properly designed, sometimes influenced by functionalism, in other cases inspired by the Scandinavian style, which was modern back then. Some projects responded well to the local context, while austerity prevailed elsewhere. However, further development took a different direction. After the victorious February of 1948, strict building regulations were introduced, and typification standards, known as “Comprehensive Housing Equipment (Construction)” or KBV were created. All private construction companies and design offices were unified under the “Československé Stavební Závody” (Czechoslovak Building Works) led by Karel Janů. Architects were organized by the state organization “Stavoprojekt”, initially led by Jan Voženílek. The

History of prefabricated housing buildings

government took on the task of providing each family with an apartment, and ruthless plans and requirements emerged to accomplish this task. Plans for residential buildings and their standards began to be simplified, and the entire construction soon reached a point where architecture and construction were in opposition. Suddenly, construction was given much greater prominence. Its quality (=maximum mass performance) became far more significant than the aesthetic quality of the building.¹⁰ Architects put together standardized buildings, which would be assembled from the fewest possible parts that could be easily and quickly manufactured in factories. The apartment standard was designed to be minimal because “every minor increase in the standard of mass housing and construction units immediately translates into a cost increase of hundreds of thousands.”¹¹

At the beginning of the fifties, Socialist Realism is implemented as a new artistic style. The first standardized system “T” is created. Apartment buildings of this system are still made of bricks and are called “holotypes.” These are very simple rectangular buildings with a gable or hipped roof. The “T15” system from 1952 has a standard of 2+1 with an area of 48m², later the 2+1 apartments were expanded to 54m² in the system “T74”. The inefficiency of brick construction leads to experiments with panel components. The first serially produced panel building in Czechoslovakia is the “G” system from 1955, designed by architects Hynek Adamec and Bohumír Kula.¹² This series kick-started the

¹⁰ STR. 234, Paneláci 1 - Skřivánkova, Švácha, Novotná, Jirkalová
¹¹ (Str. 3, *Architektonická Bilance KPÚ Praha, Otakar Nový*)
¹² (ELIÁŠOVÁ, Klára. *Třípodlažní montovaný dům* [online]. 2019 [cit. 2024-01-13]. Dostupné z: <https://zam.zlin.eu/objekt/76-tripod-lazni-montovany-dum>).



First two-year “T12” system houses, street Zlepšovatelů in Ostrava 1952¹²



A view of the winning Czechoslovak pavilion at EXPO 58 in Brussels¹³

industrial production of construction elements. However, criticisms arise that the “G” system does not adhere to precise typification, exceeds the costs for one standard apartment, and faces technical and aesthetic challenges. It also turns out that “G” system construction is inefficient. Instead of the desired cost reduction using concrete panels instead of bricks, the balance shows a 10% increase in expenses compared to the “T” series. In the next two years, designers came up with changes, and gradually “G40” and “G55” systems were created. The “G57” system is very austere in response to “insufficient artistic value and excessive resemblance to functionalism.” Later, a variant “G58” was created, which has circular windows in staircase sections.

The world exhibition EXPO 58 in Brussels in 1958 brought a breath of fresh air to the world of strict rules and regulations. The period between the late fifties and early sixties can be characterized as the Brussels style. This style manifested in architecture but also applied design and art, influencing the entire European scene.¹³ In Czechoslovakia, efforts were made to adopt a new construction approach. In 1958, work on an experimental housing estate called Invalidovna began in Prague. This site is still considered one of the most successful contemporary housing projects. It featured model apartments showcased as an exhibition and was complemented by numerous public functions, with the Olympik Hotel serving as its culmination point.¹⁴ After nearly a decade of Socialist Realism, the influence of the Brussels style was a welcome change. The buildings from this period were architecturally interesting,

¹³ (Brusel [online]. 2022 [cit. 2024-01-14]. Dostupné z: <https://www.modernista.cz/obdobi/bruselsky-styl>)

¹⁴ STR. 13, *Experimentální sídliště Invalidovna - Ladislav Zik-mund*

using a wide range of materials, and their interiors received colourful plasters and furnishings. In addition to the Invalidovna housing estate, the Králův Háj housing estate in Liberec can be mentioned as a successful example.¹⁵ Unfortunately, none of these experiments made it to mass production, remaining as individual buildings or groups of buildings only in the locations where they were designed.

In 1961, under the leadership of František Faistner, a new standardized residential building, “TOB,” was created, which became one of the most widely used and popular systems. Variants were developed, with the most well-known being “TO6B” and “TO7B”. The problem of a narrow module was addressed with the “TO8B” variant. The span between load-bearing panels increased from the original 3.6m to 6.0m. At the same time, in the early sixties, Karel Janů proposed the “PL 60” system. It was an experiment consisting of a steel skeleton supplemented by concrete, hardboard (HDF) and wooden partitions, a steel prefabricated staircase, and plastic cores. “PL 60” was intended for Plzeň, and, as it did not enter mass production, examples can only be found there.

In 1972, newly approved Standard Specifications were issued. These were a set of new thermal-technical requirements for construction, mainly concerning the construction of residential buildings. Stringent requirements constrained architects, some succumbed entirely to the pressure for production quantity and the fulfilment of five-year plans. However, a group began to form, trying to approach the assigned tasks creatively and finding the strength to resist uniformity. This gave rise to “beautiful late

¹⁵ STR. 41, *Experimentální sídliště Invalidovna - Ladislav Zik-mund*



View of the housing estate Králův Háj, Liberec 1963¹⁶

and postmodernist housing estates¹⁶ that can be found throughout the territory of today’s Czech and Slovak Republics.

In the 1970s, a new issue emerged that needed to be addressed, namely the emerging shortage of space. The boom in housing construction initiated after World War II required a lot of available land. Housing estates were predominantly built on greenfield sites on the outskirts of cities and in their vicinity. Now, these areas are slowly filling up, and it is increasingly necessary to find space in the city centres for new residential construction. Areas with buildings that do not meet hygiene requirements are being sought. Usually, buildings constructed in the 19th century are being demolished. Instead of their revitalization, these buildings are replaced by new panel construction. Domestic companies are fully focused on panel production and cannot handle other craft processes. Often, these interventions are insensitive, and there are significant losses of historically valuable buildings during this period. The end of the 1970s brought the creation of new systems that fully met the new thermal-technical requirements. These include primarily the variants of the “P” system. They allow for the creation of buildings with a sloping roof or angled corner, the possibility of inserting a bay window, or opening up the ground floor. There is an increasing emphasis on the quality of historical detail and a re-evaluation of the modernist tendencies of urbanism, which degraded into the housing estates of that time.¹⁷

In the second half of the eighties, debates began to let up, and there was a gradual reflection on the post-war construction. In 1987, the Cabinet of Architecture Theory of the Czechoslovak Academy of Sciences organized a debate with a discussion about terms and arguments of postmodernist tendencies. There was discussion about the genius loci, criticism of the Athens Charter’s indifference to traditions, and the limitations of modernist urbanistic tendencies. A year later, after the fall of communism, it became possible to freely express opinions and initiate efforts to correct the mistakes resulting from the close connection between construction and political tendencies. Typological systems created before the revolution were still used in residential construction for some time. There was an effort towards “humanization” of housing estates. Where the construction of public amenities lagged, efforts were made to complement and cultivate public spaces. However, the end of the twentieth century revealed all the questions and problems that would need addressing in the future rather than coming up with constructive plans for

¹⁶ STR. 267, *Paneláci 2 - Skřivánková, Švácha, Novotná, Jirkalová*
¹⁷ (Jiří Laskovský, časopis *Architektura ČSR*, 1980)



Construction of a panel house type “G40”, Zlín 1953¹⁸

dealing with them.

This text focused on the development of housing estates in Czechoslovakia in the post-World War II period, which largely paralleled the development of residential construction in all countries of the former Socialist Bloc. The seeds and ideas from which these housing estates emerged appeared in all countries affected by war or striving for the development of housing stock in Europe. However, the development in countries with democratic leadership took a very different direction than in totalitarian regimes.

In democratic countries, the debate was not conditioned by propaganda and not influenced by the dictatorship of the regime. The professional public was able to reflect on industrial production in construction and serial houses much earlier. Unsatisfactory aspects were captured, societal moods and demands were reflected upon, and any missteps and problematic elements did not continue to be repeated for as long as they were in our territory. The first idea, the inspiration of modernist concepts, is the same for all European countries. However, their development during the late twentieth century was very different. It is necessary to consider the different local contexts, but we can identify the same elements and examples of different approaches.¹⁸

Although systems and standardized residential buildings made of reinforced concrete panels ceased to be designed after 1989, it would be a mistake to abandon their further development in these years. Between 1950 and 1995, approximately 80,000-panel buildings were built in Czechoslovakia,¹⁹

¹⁸ KOHOUT, Michal, David TICHÝ, Filip TITTL, Jana KUBÁNKOVÁ a Šárka DOLEŽALOVÁ. In: *Sídliště, jak dál? 1. České vysoké učení technické v Praze, 2016, s. 217. ISBN 978-80-01-05905-0.*

¹⁹ *V panelových domech v Česku žijí v současnosti tři miliony*



Installation of the peripheral part of the system „T06B OS 70“¹⁶

providing 1.2 million apartments for more than 3 million residents, who were accommodated in what began to be referred to as “rabbit hutches”. After the revolution, problems associated with these structures began to multiply, prompting efforts to effectively address them. Efforts began right from the start. Initially, debates developed about the state of urban planning in newly built residential neighbourhoods. Inadequate solutions for public spaces, low population density, excessive uniformity, and similarity of the buildings were among the issues raised. Publications describing how to intervene in housing estate structures and increase their quality began being printed. Zdeňka Aulická outlines systematic approaches to regenerate housing estates and make them a contemporary place for comfortable living in her 1993 book.²⁰

Many publications focus on evaluating the phenomena of housing estates and the possibilities for their further development and utilization. Other authors address the pressing issue of public spaces, which are remnants of the theses of the Athens Charter and often function poorly in practice. There is a poorly articulated space between public spaces and private housing spaces. Buildings are often randomly placed in space as their placement arose from the strict geometric precision of plans. There is an effort to supplement public amenities, but in many cases, it fails due to a lack of knowledge of the area and subsequent low utilization. The issue of parking solutions, dimensioned for a much smaller number of cars, proves to be very problematic. Universities are

also engaged in the debate, not only civil engineering and architecture faculties. Housing estates are analysed within academic subjects, and suggestions for working with them are proposed.²¹

A comprehensive publication dealing with housing estate construction is a book “Housing Estates, What Next?”, which was created at the Faculty of Architecture of the Czech Technical University in Prague. It describes the brief development of panel housing estates but mainly demonstrates their possible future through examples of student projects and examples from abroad.²² They can be understood

²¹ ZADRAŽILOVÁ, Lucie. *Když se utopie stane skutečností. Kontexty. V Praze: Uměleckoprůmyslové museum, 2013. ISBN 978-80-7101-133-0.*

²² (KOHOUT, Michal; TICHÝ, David; TITL, Filip; KUBÁNKOVÁ, Jana a JAHODOVÁ, Šárka. *Sídlště, jak dál? Praha: České vysoké učení technické v Praze, Fakulta architektury, Ústav nauky o budovách, 2016. ISBN 978-80-01-05905-0.*)



Unfinished public spaces of housing estate Jižní Město in Prague with¹⁷

as a source of inspiration for interventions in the Czech territory. Many methods have already been tested and applied. There is a possibility to build on them and adopt certain elements with the local context in mind.

The problem with interventions within panel housing estates has become primarily the unmanageability of scale and the need to solve numerous problems in a short period of time. Many interventions were quite unsystematic, and instead of removing unsatisfactory aspects and cultivating the environment, they could contribute to worsening the situation.

Along with the effort to address housing estates as whole areas and propose a concept for their future form, it was necessary to carry out interventions within individual panel buildings. The main problem was and still is the inadequate envelope of the building. Insulation and façade repairs have become one of the most common repairs of panel buildings. However, the approach to these works has led to the proliferation of rainbow façades with pictures and the loss of detail and identity. To separate their building from others, individual cooperatives began to “outdo” each other in the number of stripes and circles on the plaster applied to a uniform layer of polystyrene, covering the structural divisions of the original façade and erasing all differences between the various types and sections. Gradually, the original Formica bathroom cores are being replaced and interior modifications are being made. The authors of the book “Modern Panel Apartment” systematically attempted in the first decade of the twenty-first century to focus on the interiors of individual panel apartments and show the possibility of a creative approach to transforming them into contemporary living spaces.²³ Many treatises on the technical condition of panel buildings and the possibility of their modernization from a technical point of view are emerging. During the second decade of the twenty-first century, the debate is significantly engaged by the lay public. There is a group of residents who unequivocally condemn panel buildings, while on the other hand, there are people with different views. Panel buildings are gaining their advocates and protectors. Databases are being created mapping the historical development, individual systems and their variants, examples of exceptional buildings that demonstrate completely unusual approaches and the brilliance of the architects of the time, who were able to bring innovative solutions despite strict conditions. In addition to publications that quickly became known to the public, such as the two books “Paneláci” and the associated exhibitions in all

²³ (POSLUŠNÁ, Iva a MEIXNER, Miloslav. *Moderní panelový byt: [nápad, úprava, řešení]. Brno: ERA, 2007. ISBN 978-80-7366-108-3.*)

History of prefabricated housing buildings

regional cities, smaller initiatives are also emerging, such as the website “panelaky.info”.²⁴

The issue of panel housing estates and panel buildings themselves is currently spanning many disciplines and it is appropriate to address it comprehensively. Continuously innovative approaches striving to unite two camps with entrenched opinions that are in opposition are necessary. Panel buildings represent almost a third of the housing stock in the Czech Republic. It is impossible to form a simple conclusion as to whether they are satisfactory. It is impossible to insist on demolishing them all, nor is it necessary to avoid any intervention. Despite obvious problems, panel buildings provide valuable housing, and by revitalizing them, we can contribute to solving many issues and adopt a more sustainable approach to construction. We live in a time when the definition of housing, as we know it, is undergoing rapid change. Housing can no longer be described by a single set of rules, and it cannot be expected that every household can adapt to such rules. It is necessary to create flexible and inclusive spaces capable of transforming over time. However, it is also not possible to continue building new structures indefinitely. The need to reduce the environmental impact of construction is more urgent than ever. Revitalisation of existing structures becomes the most environmentally friendly path we can take. And why not start with the largest group of residential buildings with similar parameters – panel apartment buildings?

²⁴ panelaky.info.cz (LIPTÁK, Marián a Tomáš PINDEL. *Paneláky. info.cz [online]. 2016 [cit. 2024-01-14]*

lidí. Archiweb.cz [online]. 1997, 2024 [cit. 2024-01-14]. Dostupné z: <https://www.archiweb.cz/n/domaci/v-panelovych-domech-v-cesku-ziji-v-soucasnosti-tri-miliony-lidi>

²⁰ (AULICKÁ, Zdenka. *Regenerace sídlště. Praha: Výzkumný ústav výstavby a architektury, 1993. ISBN 80-85124-25-4.*)



Flowers on a panel building in Plzeň^{xi}



A ladybug on the facade of a panel house in Liberec, Rochlice^{xii}



Coloured façades and balconies, Máj in České Budějovice^{xiii}



Rainbow facade of an insulated panel house in Prague^{xiv}

3. Czech panel systems development

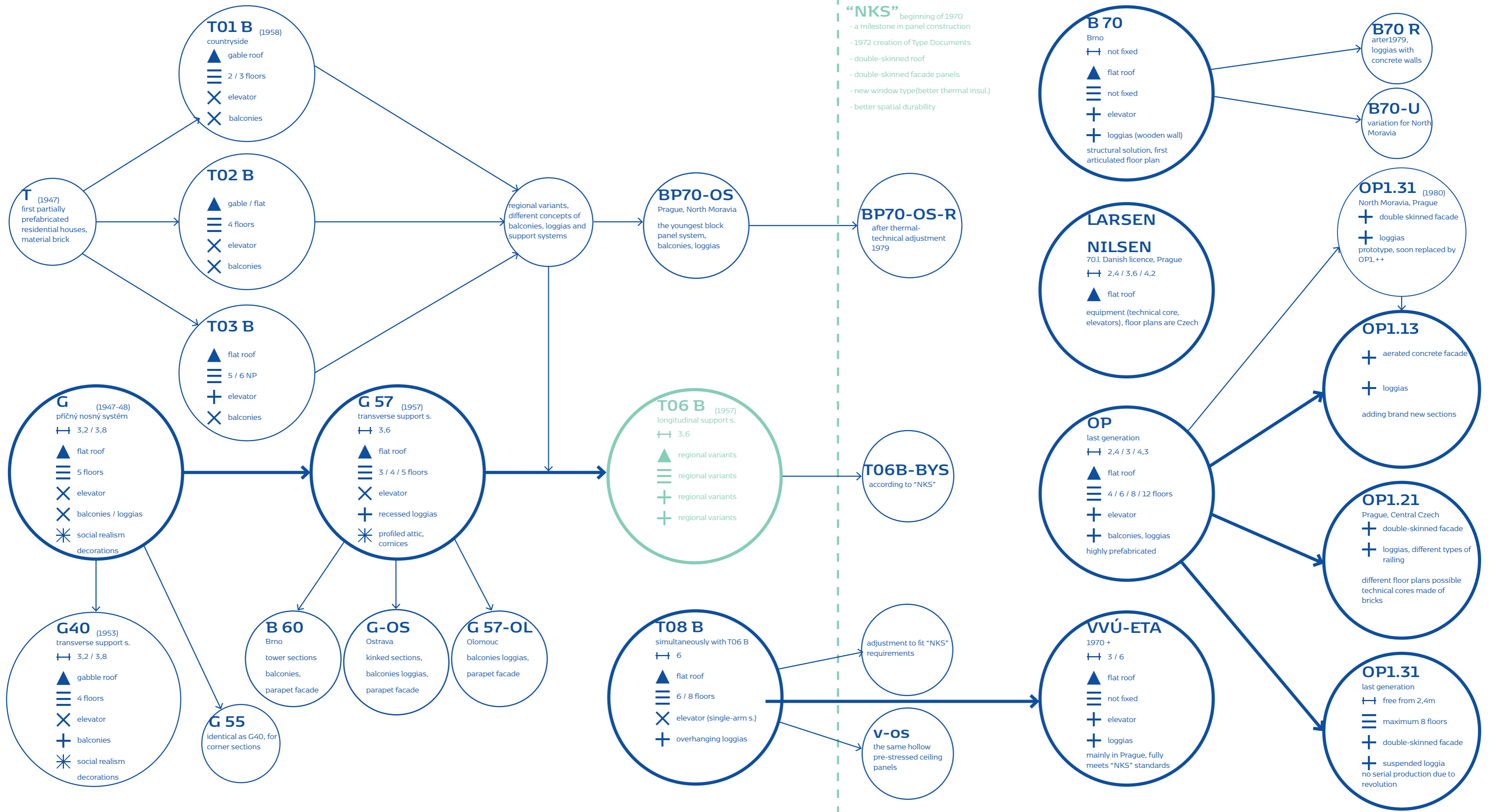

3.

Czech panel systems development

The first serially-produced systems of residential buildings in Czechoslovakia began to emerge in the late 1940s. Over the next nearly forty years, several different systems with many connecting elements were developed. The diagram presented on the previous page illustrates the systems that fundamentally shaped the technical characteristics and influenced the course of development.

Before the serial production of panel residential buildings began, efforts were made to simplify and partly industrialize masonry structures. A ground-breaking example of this approach was the 1942 **“T”** system. Its appearance differs greatly from today’s idea of a serially produced panel building. It was equipped with a gable or hipped roof, lacked balconies or loggias, and elevators were installed only in the latest variations. The most common variation is **“T01B”**, mainly used in small towns and rural areas, reaching a maximum height of three floors. Variations **“T02B”** and **“T03B”** were used mainly in larger cities and can be as high as six floors.

The first concrete panel system (**“G”** system) began to be used between 1947 and 1948 in Zlín. Its designation **“G”** refers to the former name of the present-day city of Zlín – Gotwaldov. It is a system of transverse load-bearing walls of a 3.6m span. The building is topped with a flat roof, lacks balconies and loggias, and since it has a maximum of five above-ground floors, it also lacks an elevator. The system is notable for its aesthetic aspect, significantly influenced by Socialist Realism. The façades are mostly fully plastered and have a decorative cornice. Since it is the first of its kind, the **“G”** system has many flaws and shortcomings, which architects and engineers try to eliminate through later variations.

“G40” from 1953 is equipped with balconies and features a hipped roof. The corner section variant **“G55”** is created for greater variability. The most used variant becomes **“G57”**, designated according to the year of its creation. **“G57”** buildings have a flat roof, recessed loggias, and a prominently profiled attic cornice. It is also the first system to have specific regional variations. In Brno, architects created a parapet envelope and added floor plans of new tower sections and balconies that came together in variation **“B60”**. In the Ostrava region, the most common is **“G-OS”**, which also features a parapet envelope and folded sections with loggias or balconies. The last regional variation is the **“G47-OL”** from Olomouc, which is technically the same as in the Ostrava region but differs in colour and material finish of the façades.

The knowledge and experience gained from designing



Sample of the profiled main cornice of the house **“G55”** in Zlín*

and implementing the **“G”** and **“T”** systems at the end of the 1960s provide stimuli for the creation of the future most widespread **“T06B”** system. The first panel buildings of this system begin to be built in the then South Bohemian Region and the system soon spreads to other regional areas. From the basic principle of a system of transverse load-bearing walls with a span of 3.6m and a non-load-bearing perimeter façade, a specific variant with major or minor differences develops in each region. Both linear and point variations are commonly seen. The number of floors, balcony or loggia solutions, and material finishes depends on local conditions where the given type is built.

Along with the **“T06B”**, the **“T08B”** system is developed. It introduces technology to achieve a greater span between load-bearing walls. It is possible



“T08B” in Havířov, experimental bending of the building ^{xvi}

to reach up to 6.0m instead of the 3.6m span used in all previous systems. This shift represents a significant increase in interior flexibility and the possibility of new apartment layouts. Recessed loggias and a straight staircase in shared spaces are significant for “T08B” apartment buildings. They occur in many variations, more commonly as point apartment buildings. In later variations, a folded floor plan and the addition of openings to gable walls are possible. This system uses pre-stressed hollow concrete panels as ceiling panels. The same panels are subsequently used by the “V-OS” system. In some sources, a comparison of “T08B” with the “V-OS” system can be found, but the only thing these two systems have in common is the pre-stressed hollow ceiling panels.

“T06B” and “T08B” were developed before the new construction standards in implemented in 1972. The



Larsen Nilsen in Prague Bohnice ^{xvii}

systems were later modified to ensure their technical properties meet contemporary standards. “T06B” is modified to “**T06B-BYS**”, a special name for “T08B” modifications does not emerge. At the turn of the 1970s and 1980s, their construction gradually receded, and greater attention was paid to newly created systems that fully complied with the new regulations.

NKS – New Construction Systems were issued in the 1970s as a list of newly established principles aimed to improve the technical properties of buildings. Typological documents mainly adjusted the requirements for envelope structures and their thermal conductivity. Double-skin roof constructions began to be used, sandwich perimeter panels were newly developed, and window fillings with better thermal insulation properties were introduced. In addition, greater emphasis is placed on the spatial rigidity of the building. Some systems use a rigid connection between horizontal and vertical load-bearing panels, while others achieve greater rigidity by adding stiffening walls perpendicular to the load-bearing walls.

An exception among the systems emerging in Czechoslovakia is the **Larsen Nilsen** system, which was purchased from Denmark in the 1970s and used in Prague. It was a system with load-bearing walls with spans of 2.4m, 3.6m, and 4.2m. The introduction of this system was prompted by the purchase of engineering equipment for panel production facilities, which lacked technologically advanced machines to begin construction after the introduction of NKS. With the purchase of the machines, the government also purchased a license to produce the particular panel buildings. The license primarily pertains to the production technology and technical solution of construction details such as joints between individual panels and the solution of sandwich façade constructions. For the average citizen, the difference at first glance is minimal. The buildings have flat roofs, the façade is made of wall panels, and it is smooth with slightly recessed joints. The construction and interior equipment are manufactured domestically.

In the mid-1970s, the “B70” system was developed in Brno, which responded to NKS and brought a new aesthetic concept to the façade, especially noticeable in the loggias. The loggia sides are covered with wooden walls. The system allows for folding, thus creating the first panel buildings with a complex floor plan, bringing new layouts of individual apartment units. In the early 1980s, the system was modified to type “**B70R**”, with loggia walls covered with concrete panels, and to type “**B70-U**”, which is an

adjustment for the northern Czech Republic.

The “**VVÚ-ETA**” system is a successor of the “T08B” with modifications according to new technical requirements. It is found mainly in Prague and the Central Bohemian Region. It is used for point tower buildings equipped with loggias, which are recessed or sunken. The system inherits a span of 6m and complements it with a span of 3m.

The “**OP**” system and subsequent modifications are the youngest used in Czech territory. Panel buildings from this series began to be built in the 1980s, and their modifications continued to be used after the revolution. Construction ceased around the turn of the twentieth and twenty-first centuries. Characterized is a high degree of prefabrication. The connecting elements of all subsequent variations are spans



System „VVÚ-ETA” within housing estate Jižní Město, Prague ^{xix}

of 2.6m, 3m, and 4.2m and the number of floors of individual houses is 4, 6, 8, and 12 floors. Apart from four-story buildings, the houses are equipped with elevators. The first system in this series is called “**OP1.11**” and only has fully recessed loggias. The “**OP1.13**” system creates new sections, especially for corner solutions and point tower buildings. The innovation of this system is the material solution of the façade, which is made of aerated concrete. The plaster is a part of the finishing works. The subsequence “**OP.21**” comes with a completely different solution for apartment unit layouts. It is characterized by a narrow, coloured stripe on the lower side of the façade wall panels. The loggias of this variant are recessed with a slightly protruding floor and a wide range of railing variants, including concrete panels. Occasionally brick bathroom cores



„BP70-OS-R” in Zábřeh ^{xviii}

are present. “OP.21” occurs mainly in northern Bohemia. The construction of the last variation with the designation “**OP1.31**” began at the end of the 1980s. Its expansion throughout the territory was planned but ultimately did not happen due to the revolution. The completed buildings have complex floor plans and interesting solutions of suspended coloured-concrete loggias. The system uses spans of 3 and 4.2m, and buildings have a maximum height of eight floors.

Panel buildings built during the socialist regime can be generalized in many respects. However, focusing on the details of individual panel buildings can reveal many atypical elements and deviations from the original plans and standardized documents. The mentioned systems provide a rough picture of how different technological elements and procedures developed and with what significant prefabricated elements the architects of that time could work. Many projects adopted the typical floor plan of a given system and series, merely stacking it on each other or placing individual sections side by side. But many other projects are innovative and creative, and we see attempts to turn the given “construction kit” into more imaginative and individual solutions.

Knowledge of individual systems can help us understand the construction of specific buildings and their fundamental elements much better. Knowing how individual phases developed makes it easier to approach current interventions. Panel building systems can seem very restrictive in further work with them. However, they have straight and clear rules, which can be transformed into an undeniable advantage.



Current state of „T08B” in Liberec, Františkov^{xx}



The current appearance of the segmented facade of the “G40” system^{xxi}



Loggia solutions and of “OP.1.31” system, the youngest Czech system^{xxii}



Partly renovated façades of the system „VVÚ-ETA”, Jižní Město Prague^{xxiii}

4. System T06B

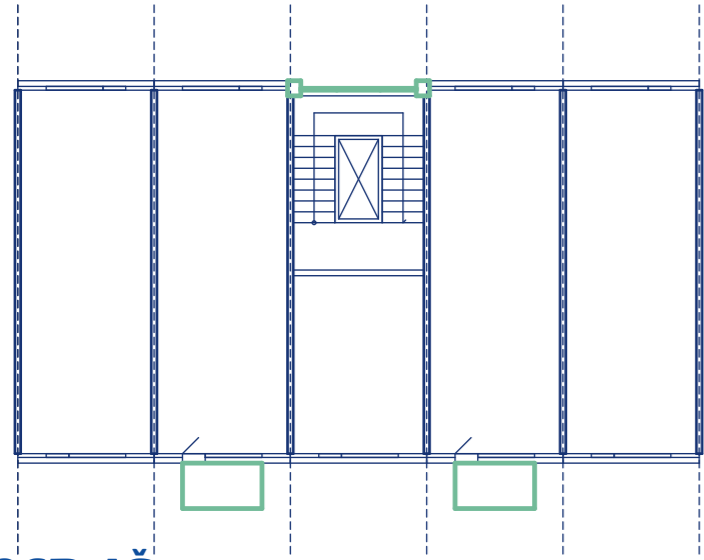

T06B-JČ South-Bohemian region

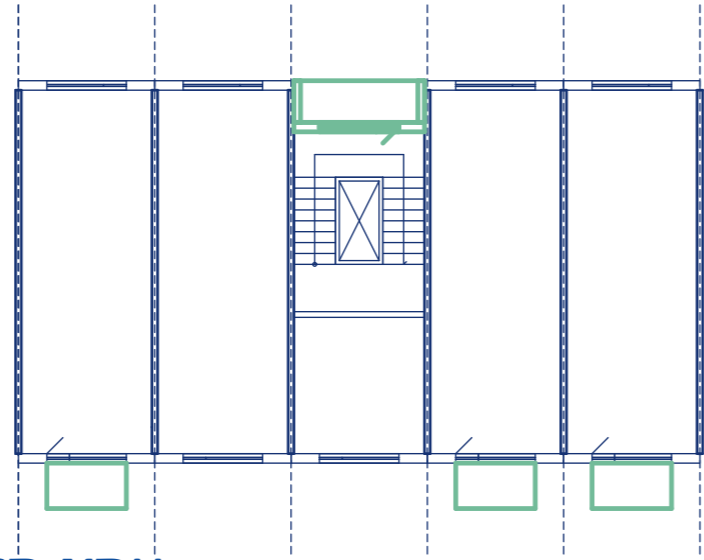

T06B-KDU South-Moravian region

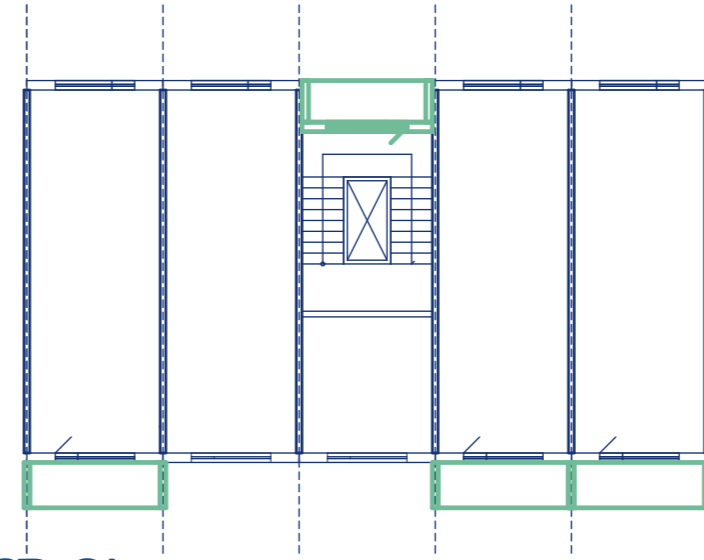

T06B-OL North Moravia region

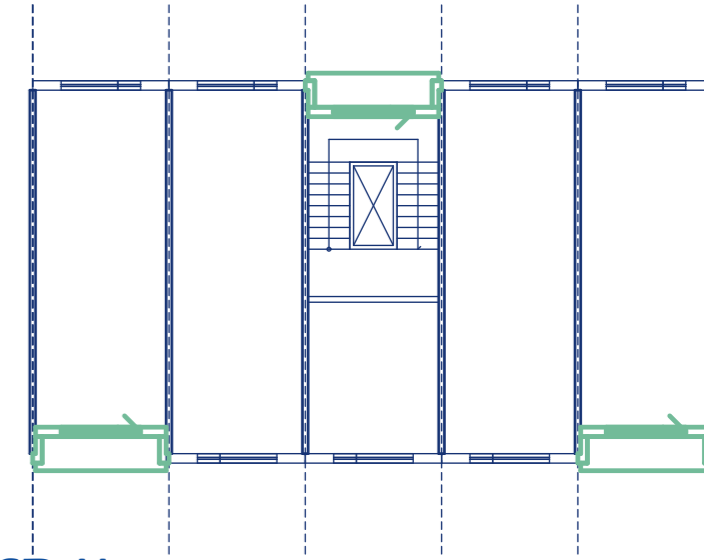

T06B-U East Moravian region

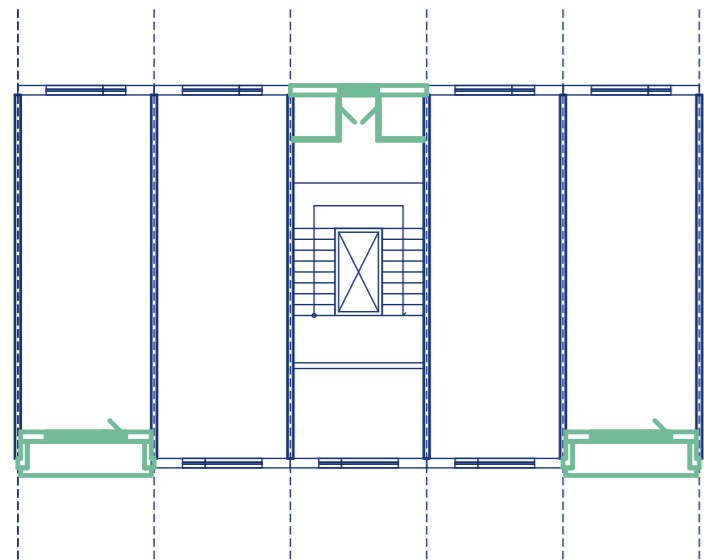

T06B-PL West Bohemian Region

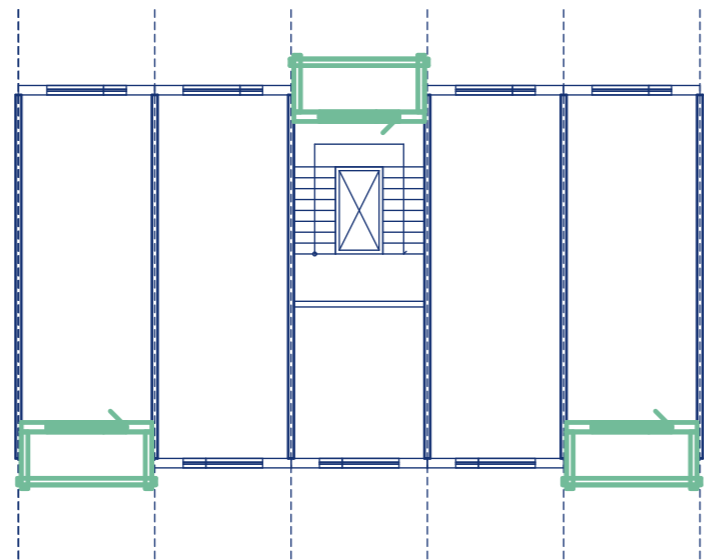

T06B-KV West Bohemian Region

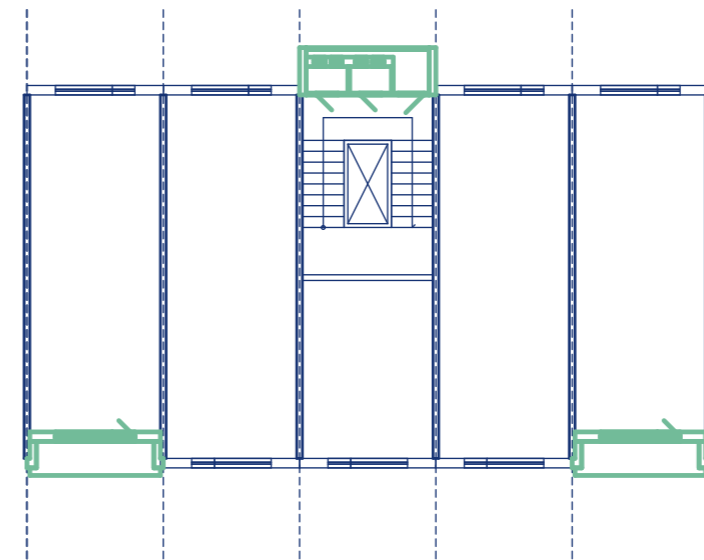

T06BU North Bohemian region

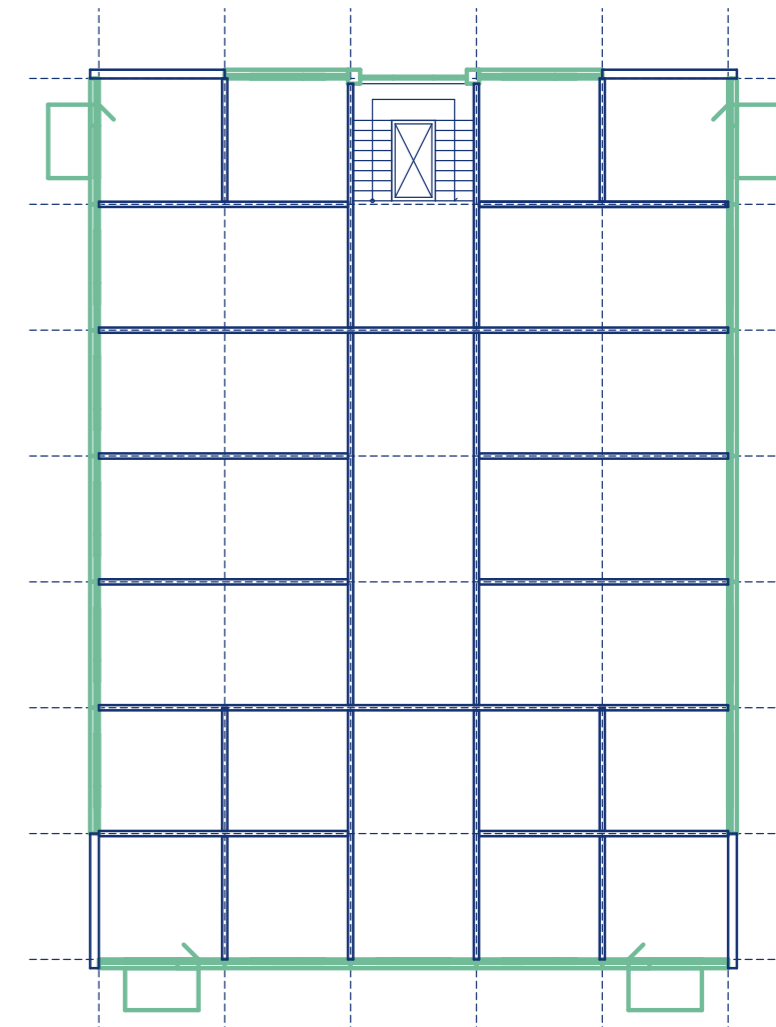

T06B-U Prague

4.

System T06B

4.

**System T06B
evaluation and division**

The “T06B” system began to be designed in the early 1960s and became the most widespread system of panel buildings in the Czech Republic. The basic parameters of the system were designed in Prague and further adapted into regional variants by individual regional project institutes. Therefore, different system interpretations can be found in all parts of the Czech Republic. The variants differ in the design of balconies, materials, and the composition and layouts of individual housing units. Often, several variants are offered in one region, and they evolve further with modified versions corresponding to changes in typological standards and budgetary requirements over time. It is necessary to bear in mind that during the communist regime in Czechoslovakia, the current area of the Czech Republic was divided into eight separate regions, including the capital city of Prague. The regional variants described below correspond to the original boundaries of the regions, which differ from the current ones.

The first panel buildings of this series began to be built in the South Bohemian Region and were labelled “**T06B-JČ**”. The façade of the panel buildings is horizontally divided into strips, consisting of a system of parallel panels with insulation inserts between windows. A prominent feature of this variant is the suspended steel balconies, which have a subtle and elegant structure. The tubular steel railing gives the structure an airy appearance. The gable walls of some buildings have French windows. The staircase corridor is integrated into the façade as a horizontal glazed strip. After 1972, with the introduction of standardized construction systems, the variant transformed into “**T06B-JČ-R73**”, with changes in layout and balconies.

In the South Moravian Region, the “**T06B-KDU**” variant was used. It was designed in Brno and distinguished primarily using slightly recessed loggias located at the level of the intermediate landing of the staircase space. The established steel balcony structures are also used in this variant, with corrugated sheet metal or glass railings. The façade is made of window sill panels. The typical insulation inserts between windows are made of concrete and have a ribbed profile. In some cases, the ribbing is replaced by a coloured mosaic. Point block buildings of “**T06B-KDU**” are used mainly in the South Moravian Region.

The Moravian-Silesian Region develops two basic variants, “**T06B-OL**” and “**T06B-OS**”. In the “**T06B-OL**” variant, façade panels with visible joints are used. The panel buildings mostly have fully extended balconies. There are also Recessed loggias located at the level of the intermediate landing. The “**T06B-OS**” variant can only be found in Ostrava and Frýdek-Místek. The characteristic feature is the use of concrete mixed with added slag. This variant is very extensive, and individual projects use several atypical elements. Its modifications, addressing thermal insulation problems or variations in layouts, are “**T06B-OS70**”, “**T06B-OSR**”, and the youngest, “**T06B-BTS**”.

In the Eastern Bohemian Region, the “**T06B-U**” variation is used. Again, the principle of horizontal façade division is applied using parapet façade panels covered with loose crushed stone, giving the façades of houses a sculptural quality. The loggias of this variant are completely recessed with a slightly projecting floor element, which profiles the façade. The loggias are located at individual housing units



„T06B” system housing buildings in Prague, Ďáblice^{xxxiv}

and the level of the intermediate staircase landing. This variant uses a uniform window opening size.

The Central Bohemian variant is labelled **“T06B-SČ”**. Row housing panel houses with a parapet system of façade panels and insulation inserts between windows are the most commonly built. The residential buildings don't have basements but a technical ground floor, where instead of residential units, there are storage compartments for individual apartments and technical rooms. The ground floor is set back, higher floors are supported by a cantilever system. In addition, the façade of the ground floor is, made of translucent vertically placed glass panels, creating a different interaction with the surrounding environment. The loggias have slightly projecting floors, and the railing is made mostly of lightweight materials.

The most extensive development is seen with variants from the West Bohemian Region, both of which extend beyond the region boundaries and introduce new significant elements to the original construction. The “T06B-KV” variant was created in Karlovy Vary and is very easily recognizable due to the attic on the gable walls. The attic follows the angle of the roof planes sloping towards the drainage valley in the centre of the building. This detail is preserved even on the buildings that have undergone renovation. The façade is usually flat, and whole wall façade panels are used. The railing of the balconies is made of concrete panels with pressed decorative motifs, which began to be used after 1968. The pressed motif is also used on panels of the gable walls of the buildings. With the advent of standardized construction systems, it is necessary to start modernizing panel factories that are unable to ensure the technological production



Variant „T06B-BTS“ Ostrava Region^{xxxv}

of newly required quality panel prefabricates. The “T06B-KV” system in West Bohemia is modified to meet the required standards to delay the necessary modernization of panel factories. New features include generously extended balconies and sections working with the recessing of the façade, offering a new standard of layouts. This variant is used until the first half of the 1980s. The second West Bohemian variant is **“T06B-PL”** originating in Pilsen, which is easily recognizable by the arrangement of the intermediate landing of the staircase space. Where the storage spaces are created. This feature is reflected on the façade using narrow French windows which have vents on both sides. This feature is separated on each floor by a short inter-floor cornice profiling the façade. This variant is used until the end of the 1970s.



A view of system „T06BU“ housing estate Františkov, Liberec^{xxxvi}

In the Northern Bohemian Region, the variant **“T06BU”** is used, its marking refers to the town of Ústí nad Labem, where it was designed. The first-panel building of this variant began construction in 1963. The façade is horizontally divided by parapet façade panels, and insulation inserts between windows have a metal surface, using corrugated metal after 1968. Window openings initially have three wings, later using typical window openings with one large pivoting wing and one small tilting wing. This variant uses recessed balconies with slightly projecting floors in individual housing units. Storage spaces are located at the intermediate landing level. In some variants, there are two separate storage spaces, while other variants use this space for a pantry for apartments adjacent to the staircase space. In most variants, storage spaces are combined with balconies. There

does not have a specific name but has very specific features. There are only a handful of point, high-rise panel buildings of the **“T06B”** system in Prague. These buildings are designed in a square floor plan grid. A 3.6m module is applied in both directions. The staircase is located on the shorter façade, structurally separated from the internal access corridor to individual apartments and ventilated. This solution is very progressive in terms of fire resistance solutions for high-rise buildings. There are seven housing units on one above-ground floor. All completed buildings have 14 above-ground floors. The variant uses suspended steel balconies, parts of the façade are horizontally divided by parapet façade panels, and parts are smooth without openings. Most variants gradually ceased to be used at the end of the 1970s. The biggest problem is the narrow 3.6m module between load-bearing walls, adopted from early systems developed in the early 1950s. There is an effort to break free from constrained layouts that no longer meet users' requirements. Technical deficiencies also need to be addressed. “T06B” was gradually replaced by newer systems, especially from the “OP” series. However, no subsequently applied system experienced such expansion and a variety of solution variants and uses.



„T06B-PL“ system buildings with statue, Plzeň^{xxxvii}

are two doors to two storage openings and glass doors providing access to a small outdoor space of the recessed balcony at the intermediate landing level. The cladding structure of these balconies consists of dark-coloured concrete panels, creating a distinct vertical division of the façade. Another variant labelled **“T06BU-78”** is designed in Chomutov. The main feature of this variant is the use of intermediate window pillars instead of insulation inserts and the modification of balconies. Slightly projecting balconies are newly framed by projecting sides, and the entire balcony row acts as a framed vertical element, significantly changing the appearance of the entire façade.

In the capital city of Prague, variants developed in surrounding regions, especially in Central Bohemia, are used. The variant created specifically for Prague



New facade on panel building of system "T08B", Lierec^{xxviii}



Current state of „T06B-PL“ façades, Plzeň^{xxix}



Current state of housing estate Severní Terasa, Ústí nad Labem^{xxx}



A view of T06B a T08B houses in Lierec^{xxxi}

4. System T06B analysis

Most of the buildings have basements; on the first underground floor, where the cellar compartments, and the elevated ground floor of the building to accommodate at least two residential units. There are cases of buildings without basements, where cellar compartments are located on the entrance or amenities floor, and residential units are situated from the second floor upwards.

The materials used and the execution of individual structures depend on the regional variant and the characteristics of the specific project. The basic section can be assembled to create various schemes of residential buildings. Sections are most commonly used in linear buildings, with the possibility of application to point buildings.

To obtain detailed information about the buildings of this system, the research has been divided into eight parts. These parts closely examine topics that significantly influence the appearance and functioning of the building as an independent element and as a component within the environment of the specific location. The first four parts (structural system, façade, roof, and technical equipment) primarily address the technical aspects of the entire building, its efficiency, and the condition of its structures. The second half of the list (layout, common areas, ground floor, and nearby surroundings) focuses on the parts of the building with which people interact the most. These are the building sections where important events take place, shaping the image of the building in the eyes of residents, visitors, and passers-by. Each part includes reference projects that deal with the theme of the respective part and can serve as inspiration for subsequent interventions.

The "T06B" panel system is a synthesis of knowledge from the series "T" and "G" systems developed after World War II. It incorporates certain aspects and improves the quality of technical execution and the level of industrialization of individual building elements. The typical layout is statically simple, consisting of five parts divided by load-bearing panel walls spanning 3.6 meters, oriented horizontally with a gable façade. The entrance and the main staircase are placed in the central part. There are usually two or three apartments on a typical floor of one section, one of which is a studio.

The front and back façades are non-load-bearing and can be made using full-wall panels, parapet façade panels with inter-window insulation inserts, pillars, or any combination of the above. The buildings have a flat roof drained by gutters and a central downspout.

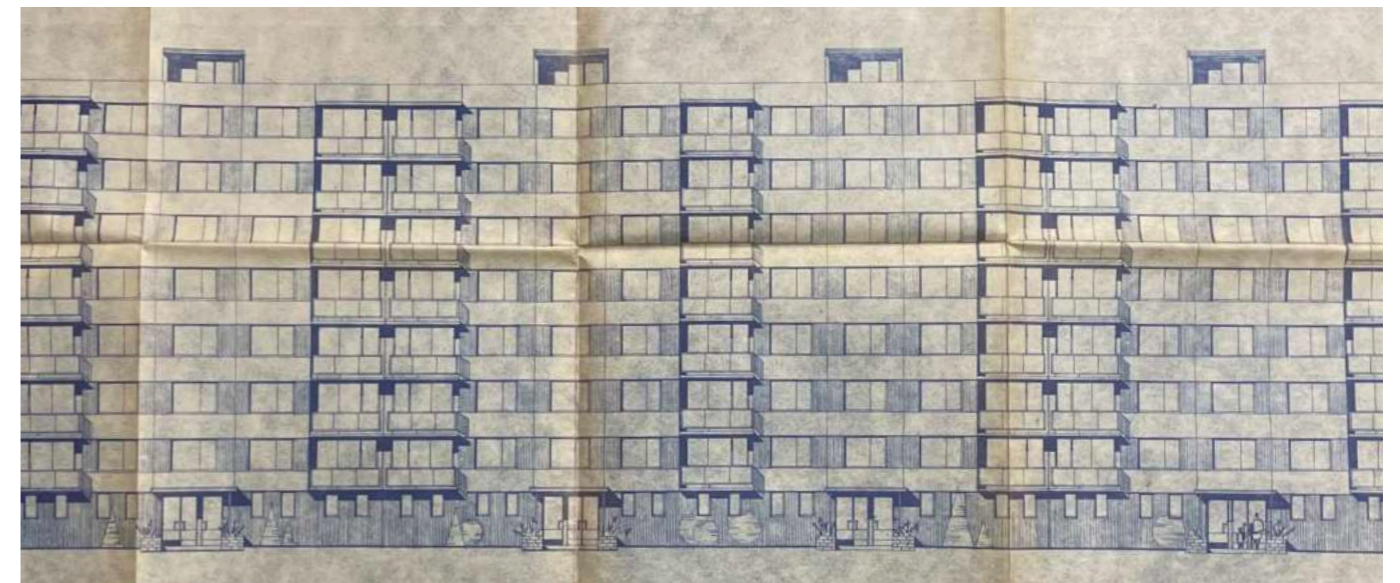

Elevation, T06B Liberec Františkov xxxii

surroundings

S

- there is ample space and greenery around individual buildings due to the nature of housing estates

W

- the spaces are often poorly articulated and graspable
- the greenery is disorganized, and in many cases, residents do not take care or do not have any relationship with it

- articulating the space can create a better understanding of public versus private areas and improve the connection of the building with the exterior
- the space can also be used for potential extensions

- unused and deteriorating public spaces can have a negative impact on residents' sense of belonging and safety.

O

The spaces near residential buildings provide an area where many activities, meetings, and play can take place. They serve as a soft transition from public to private spaces. If these areas function well in connection with the ground floor of the building, they have the potential to revitalize the entire area and bring new value not only to residents.

Adjacent spaces can complement the functions found within the building and provide their extension into the exterior. Whether it's a communal room complemented by a private garden, a café expanded with outdoor seating, or space for growing plants and small fruits or vegetables.

Outdoor spaces also play a significant role in environmental stress and its proper functioning within ecosystems. Their task should be to create a favourable micro-climate, regulating temperatures in summer months, wind speed, air humidity levels, and rainfall infiltration.

T

Pedestrian zone among the housing buildings^{xxxiii}

Olympic Park Munich

author:

year:

place: Munich, Germany

description:

In the case of the Olympic Village in Munich, it is necessary to keep in mind the exceptional nature of the initial concept and the conditions under which the facilities were created. The former accommodation for athletes was conceived as a future residential district for various groups of inhabitants throughout the whole design process. Today, it is one of the most lucrative parts of Munich, not only due to the accessibility of sports facilities but primarily for its high-quality living spaces and public areas.

The designers succeeded in creating an exceptional harmony between smaller row houses and several extensive apartment buildings, both linear and point blocks. The spaces that are in direct contact with the individual buildings are clear, well-articulated, and yet pleasant. They are filled with greenery in many forms and variations. Visitors can easily sense the boundary between the public and private space without the need for fences or other elements that “protect” privacy.

Panel houses in the former Munich Olympic village^{xxxiv}

Transformation of 530 dwellings

author: Lacaton & Vassal

year: 2017

place: Bordeaux, France

description:

The project focuses on renovating three residential blocks in the Cité du Grand Parc housing estate in the French city of Bordeaux. The main idea is to utilize the existing inadequate residential buildings and transform them to meet contemporary housing standards.

The architects have opted for minimal intervention in the existing structure and proposed additions and extensions. The additions expand the spaces of the loggias, providing each apartment with a new living area in the form of a winter garden. The designers refer to this method as the “Plus system”, drawing from their experience from a previous project involving the transformation of a residential building in Paris. Additions to the flat roofs of the buildings have created new internal communal spaces, which are connected to the outdoor areas of the newly accessible flat roofs.

Interventions within the buildings primarily involved the transformation of staircases and corridors. Works carried out in private apartments were planned to minimize disruption and were completed within a short timeframe. The renovation of one apartment unit core took five days, while the replacement of one window opening took half a day.

Transformation de 530 logements, bâtiments G, H, I, quartier du Grand Parc - Lacaton & Vassal, Druot, Hutin Transformation of 530 dwellings, block G, H, I. LACATON & VASSAL [online]. 2017 [cit. 2024-01-21]. Dostupné z: <http://www.lacatonvassal.com/index.php?idp=80#>

Open ground floor with a connection to a pocket park^{xxxv}Parking places integrated to the pedestrian zone and greenery^{xxxvi}

Related publications:

- *Veřejný prostor v éře reálného kapitalismu. Archiweb [online]. 2011 [cit. 2024-01-25]. Dostupné z: <https://www.archiweb.cz/n/salon/verejny-prostor-v-ere-realneho-kapitalismu>*
- *KOHOÚT, Michal; TICHÝ, David; TITTL, Filip; KUBÁNKOVÁ, Jana a JAHODOVÁ, Šárka. Sídliště, jak dál? Praha: České vysoké učení technické v Praze, Fakulta architektury, Ústav nauky o budovách, 2016. ISBN 978-80-01-05905-0.*
- *KOOLHAAS, Rem. Countryside a Report. 1. Taschen, 2020. ISBN 978-3-8365-8331-2.*

S

- not part of the building's structural system
- rhythmically placed windows
- balconies/loggias
- rare examples of the use of high quality surface materials

W

- poor thermal-technical properties
- original windows do not meet today's technical standards
- monotony and a sense of mechanization, especially in larger residential complexes
- does not facilitate easy orientation in the area and a sense of belonging

- almost unlimited interventions
- creation of a better integration between interior and exterior
- enlargement of the apartment space with extensive outdoor areas
- use of different materials
- improvement of the neighbour relationships and sense of belonging of the residents

- degradation due to a lack of maintenance
- degradation into lifeless colour fields without detail during unsystematic insulation
- high operating costs if there is no at least partial modernization

O

The exterior cladding panels are separate units that do not bear the building's load and are anchored to the structural framework at each floor level. In extreme cases, the cladding could undergo complete replacement—a drastic modernization. The historic façade includes balconies/loggias and relatively large window openings, providing ample daylight to the living spaces. The most pressing issue is addressing the thermal-technical properties and the associated formation of unsightly insulated façades.

T

numbering above the entrance can be added for easier orientation. There is an apparent effort to vary the entrance spaces and differentiate them from others. These spaces are crucial areas in residential buildings, where residents and visitors pass through daily, and their thoughtful design can contribute to a sense of security and privacy.

The exterior cladding has the potential to play a crucial role as a landmark in the vicinity, in fostering a sense of belonging among residents, in linking interiors with exteriors, and in enhancing the quality of individual home interiors.

Original façades in most T06B panel buildings are distinctly horizontally segmented. Visually, they create horizontal bands within which window openings are located, with strips between them often made of different materials or at least different colours. The façade is strictly rhythmical. The individual façade elements can create pleasant detail in smaller clusters of two to four sections. In larger complexes, they become monotonous and fail to establish the distinctive character necessary for identification with the place and clarity of the entire area.

Entrances to individual buildings are mechanically repetitive of the same simple design. The main entrance may be framed by a roof or a flowerpot, there may be a bench by the entrance. Different materials, such as natural stone, are used occasionally to emphasize the entrance.

In renovated façades of linear structures, which often have three or more entrances, prominent

Revitalisation of a panel house in Rožnov I.

author: holiš + šochová architekti

year: 2013

place: Rožnov pod Radhoštěm, Czech Republic

description:

The project focuses on the comprehensive revitalization of the exterior cladding of a panel building in Rožnov pod Radhoštěm and the modification of its entrance area, including the main and side entrances.

The implementation arose as an alternative to conventional façade revitalizations, which typically involve systematic insulation using standardized projects by construction companies, often without any connection to the specific building and its surroundings. The budget for the implementation was identical to the budget for the mentioned systematic insulation methods.

The newly insulated façade of the building was finished with a rough-textured sand-coloured plaster. The balconies received a lighter plaster shade. The new railing glazing is made of black HEA beams. HEA beams were also used to create a roof structure over the main entrance, complemented by a wooden ceiling. The outdoor staircase is made of prefabricated concrete. The entrance area was paved, and bike racks were newly installed in front of it.

*REKONSTRUKCE PANELÁKU - ROŽNOV I. Holiš + šochová architekti [online]. 2010 [cit. 2024-01-21]. Dostupné z: <https://www.hsarchitekti.cz/cze/projekty/rekonstrukce-panelaku-roznov-i>
Holiš + Šochová architekti - Revitalizace panelového domu v Rožnově. Katalog.Earch.cz [online]. 2021 [cit. 2024-01-21]. Dostupné z: <https://www.earch.cz/katalog/projekty-a-realizace/holis-sochova-architekti-revitalizace-paneloveho-domu-v-roznove>*



Thermal insulation with new plaster and loggias^{xxxvii}



Detail of the new entrance roof structure^{xxxviii}

Loggia extension

author: re:architekti

year: 2022

place: Prague, Czech Republic

description:

At first glance, it may seem like a relatively small change, but it has a significant impact on the value of the apartment units in the panel building in Prague 10.

The architects focused on the revitalization by making changes according to the results of an initiative of the chairwoman of the “SVJ” (Apartment owners Association) of the addressed panel building. After discussion with all “SVJ” members, the interventions were limited to the balconies. They were expanded, connecting two separate balconies belonging to each apartment into one long continuous balcony.

The entire added structure respects the original structural elements. Only the parapets in the apartments were pierced and lowered where the owners wished. The choice of flooring material was also left to the individual apartment owners. Some balconies use larch boards, while others have wooden plastic boards. The structure can be glazed later if any owner wishes to create a winter garden in the future.

Thanks to the inset construction, the façade of the building gained a new detail while preserving the original structural principles and respecting the different requirements of the owners of individual apartments.

Rozšíření lodžii panelového domu. Re:architekti [online]. 2024 [cit. 2024-01-22]. Dostupné z: <https://rearchitekti.cz/rozsireni-lodzii-paneloveho-domu/>



The facade with the enlarged loggias^{xxxix}



Details of windows and openings to the loggias^{xl}

<p>S</p> <ul style="list-style-type: none"> - flat - simple structure 	<p>W</p> <ul style="list-style-type: none"> - poor thermal-technical properties - does not function as a fifth facade (=not aesthetically pleasing) - unused space - not designed with appearance in mind - inaccessible - elevator and shaft outlets
<ul style="list-style-type: none"> - large scope of possible changes - accessibility - roof extensions - extensive greenery, rainwater harvesting - placement of sustainable energy sources (solar panels, heat pumps) 	<ul style="list-style-type: none"> - it is necessary to verify the structural resistance and ensure safety, especially regarding falls - coordination of TZI (technical equipment of buildings) and potential additional operations - potential safety risks for residents if it would become accessible <p>T</p>

Many existing residential buildings of the T06B type suffer from roof defects and their unreliability. There are numerous cases of roof covering repairs and insulation upgrades. The roof structures are inadequate in terms of thermal insulation properties and soundproofing.

The rooftop space has one of the greatest potentials to bring additional quality to the building. It is feasible to create a habitable rooftop area, which can serve as a community space, private gardens, or even a commercial space with a gastronomic focus.

Another option lies in rooftop extensions. It could involve creating brand-new residential units of higher standards or spaces for commercial or public amenities.

Smaller interventions could contribute to more environmentally sustainable functioning of the current building. It is possible to create extensive green roofs combined with rainwater harvesting and retention, which would contribute to creating a more pleasant micro-climate. Installing sustainable building equipment is another possibility. Heat pumps and solar panels can help reduce heating and energy costs. However, the design and placement of these technologies are closely linked to the specific location and should be designed in consultation with experts.

Revitalisation-green roof^{xi}

Extensive green roof in Brno-Bohnice

author: Top Green

year: 2020

place: Brno, Czech Republic

description:

The poor condition of the roof structure of a panel building on Švermova Street in the Bohnice district of Brno led the housing cooperative to discuss repair options. The chosen solution is an extensive green roof. It was chosen with consideration of the financial support provided by the city of Brno for green roofs through subsidies.

The critical aspect was the load-bearing capacity of the roof structure, for which a professional structural assessment was conducted. Since the traditional extensive green roof system wasn't possible to use, a part of the substrate was replaced with recycled polyester boards to create a "lightened" version.

The green roof serves as a new surface treatment for the structure, retaining rainwater that falls in the area, not reflecting UV radiation, and reducing sound levels. The roof layers also act as insulation and prevent the upper floors of apartments from overheating, solving a long-standing issue.

The extensive greenery contributes to a favourable micro-climate in the area and provides a habitat for various insects. Its maintenance is inexpensive, requiring attention only twice a year.

Extensive greenery on a panel house in Brno-Bohnice^{xiii}

Green roof on a panel house

author: Green Ville

year: 2018

place: Pardubice, Czech Republic

description:

One panel building in Pardubice, which functions as a retirement home, underwent revitalization by adding a rooftop extension to increase its capacity. A new green roof around the rooftop extension was created by the Green Ville company. It consists of a rooftop terrace with both extensive and intensive greenery.

The terrace is designed to accommodate seating areas, flower beds with decorative flowers, and areas planted with walkable vegetation. A pathway allows passage through the area of walkable vegetation. Flowerpots are placed along the edge of the terrace, forming a visual barrier and providing privacy.

A rock path within a green roof area^{xiii}Tall greenery in pots^{xiv}

Related publications:

- MVRDV. Rooftop catalogue [online]. 2. Ulltgever, 2021 [cit. 2024-01-22]. Dostupné z: <https://rotterdamshedagen.nl/wp-content/uploads/2022/12/Rooftop-Catalogue.pdf>
- VARCABA, Stanislav. Rekonstrukce plochých střeš panelových domů. České Budějovice, 2017. Bakalářská práce. Vysoká škola technická a ekonomická Ústav technicko-technologický.

¹ Green Roof on a Block of Flats in Brno. Adaptterra awards [online]. 2024 [cit. 2024-01-22]. Dostupné z: <https://www.adaptterraawards.cz/en/Databaze/2022/Zelena-strecha-na-panelovem-dome-Brno>

ZELENÁ STŘECHA NA PANELÁKU PARDUBICE. GreenVille [online]. 2024 [cit. 2024-01-22]. Dostupné z: <https://www.greenville.cz/zele-na-strecha-na-panelaku-pardubice.html>

technical equipment

S

- the distribution systems are routed to separate shafts (each apartment has its own shaft)
- the distribution systems are easily accessible for repairs
- there are a reverse circulation systems in younger buildings
- there are detailed documentations in the archives
- modular and durable structural system

O

- possibility to design and implement more sustainable methods and technologies
- use of potentially revitalized structures (especially modernized façades and roofs) for the implementation of desired technologies
- possibility of systematic structural interventions (with the assistance of structural consultations)

The current condition of existing systems and whether any degree of replacement has already occurred is crucial when evaluating technical equipment. There are numerous interventions available, particularly in the realm of sustainable resources and technologies. Often, the most significant difference comes with preventing losses and increasing efficiency in the economics of commodities. Technical equipment in buildings is closely tied to the specific locality. There is a need for different approaches within the Czech Republic, especially concerning sustainable resources, such as solar or wind energy. A separate consideration is the management of rainwater, which is becoming an increasingly valuable commodity. Flat roofs provide an opportunity for retention and subsequent reuse of rainwater or infiltration at discharge places. There is an increasing demand for effective shading and cooling of interiors during the summer. By adding appropriately designed external shading in the form of blinds or additional shading structures, we can shade the interior and achieve a pleasant environment without mechanical cooling. If it is necessary (or desired) to install air conditioning units, careful consideration should be given to their incorporation into the façade. Examples include wooden boxes or various niches and openings that conceal the technology to avoid disrupting the aesthetic appearance of the façade. Technical building systems can also play a crucial role in the design of new functions, not only within the ground floor of the building. Different services have very different requirements for commodity supply and waste disposal. Gastronomic services can be very demanding in terms of energy consumption. It is also necessary to consider the intersection of services and the maintenance of hygiene requirements. New technical infrastructure installations can

W

- outdated technologies
- current sustainability principles are not applied
- uniform solution lack of individualization
- rigid and narrow module (3.6m)
- wall system - does not allow highly flexible layout

T

- „over-automatisation“ combining too many types of technology
- potential use of technology that will only be utilized halfway or may not be economical
- loudness of some devices (especially heat pumps)
- risk of irreversible damage during unsystematic and uncontrolled interventions

pose challenges, especially when dealing with panel buildings. Drilling works are challenging within reinforced concrete panels, both load-bearing and non-load-bearing. It may be challenging to install the new technologies within the existing shafts. Alternatives, such as installation vestibules or technical false ceilings, may be considered in case of lack of space.

The structural system is logically defined. The entire building is supported by lateral load-bearing walls, ceiling decks and stiffening cross partitions. The structure is stable, yet the narrow module between the load-bearing walls allows only limited interventions within their framework. The layouts of apartments and other interior spaces are tied to this module.

Controlled interventions, consulted with a structural engineer, are advisable. Including the addition of enlarging openings in both walls and ceilings. The existing structure's load-bearing capacity must be respected when considering potential extensions. Extensions may function with partial support from the existing structural scheme, designed as self-supporting. Embedding new structures and equipment will again require necessary assessments regarding the load-bearing capacity and stability of existing structures.

Wear and tear on the structures can be expected primarily at the joints of prefabricated panel elements, namely horizontal and vertical connections. Enhancing durability can be achieved through repairing existing joints, supplementing them with sealant, or adding reinforcement where the highest stress occurs.

Sound insulation and vibration transmission within the structure can be problematic, in projects where the load-bearing horizontal panels are welded to the load-bearing vertical panels.

Transformation de la Tour Bois le Prêtre

author: Lacaton & Vassal

year: 2011

place: Paris, France

description:

The transformation of a panel building from the 1960s in Paris serves as an example of utilizing the existing structure and adding extensions for enhanced comfort of individual apartments. Architects proposed self-supporting extensions that would replace the original façade and create larger space for the original apartment units, expanding the living rooms, winter gardens, and balconies.

Simultaneously, the extensions revitalized the entrance level of the building. The entrance floor was levelled with the terrain. A larger and more open hall space replaces the original technical rooms. Connected to the new semi-private garden area created behind the building, there are new common spaces room on the ground level.



Roof structures and loggia extensions^{xvi}

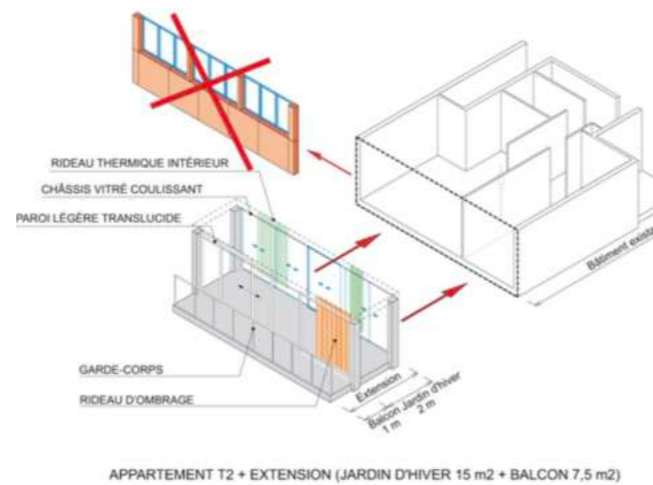

Structure of the extension^{xvi}

Transformation de la Tour Bois le Prêtre - Paris 17 - Druot, Lacaton & Vassal Transformation of Housing Block - Paris 17°, Tour Bois le Prêtre - Druot, Lacaton & Vassal. Lacaton & Vassal [online]. 2011 [cit. 2024-01-25]. Dostupné z: <http://www.lacatonvassal.com/index.php?idp=56#>

Panelák

author: Gut Gut

year: 2014

place: Rimavská Sobota, Slovakia

description:

This project is a comprehensive reconstruction of an uninhabited panel building in Rimavská Sobota. The designers themselves describe it as an attempt to answer the problems of these types of housing buildings.

The architect added a new rooftop extension with the highest standard apartments to the existing structure. New community spaces replaced the original technical ground floor. A fitness centre, sauna, and café are placed on the ground floor, seamlessly connected to the outdoor terrace area. A concrete extension at the ground level forms a covered outdoor entry space and serves as a background for the outdoor communal areas and the café terrace.

Combining the original apartment units creates new layouts of apartments with higher standards. The apartments are equipped with new private outdoor spaces formed of steel-suspended balcony structures, complementing the smooth and simple surface of the plastered façade. Apartments on the top floor have access to a private rooftop terrace.

Panelák. Gut Gut [online]. 2013 [cit. 2024-01-21]. Dostupné z: <https://www.gutgut.sk/PANELAK>



Roof extension and enlarged balconies^{xvii}



Structure of the new extension^{xviii}

Related publications:

- ČECHOVÁ, Pavla. *Potenciál bydlení v panelových domech - možnosti úprav systému T06B v závislostech typologie a konstrukční soustavy. 1. /.*
- JANOUŠKOVÁ, Šárka (ed.). *Informační příručka pro vlastníky, správce a uživatele panelových bytových domů. Technická podpora programu PANEL. Praha: Informační centrum ČKAIT, 2002. ISBN 80-86364-94-1.*

Facade photovoltaic panels^{vlix}Winter gardens and green house^l

Solhusen Gårdsten

author: Nordström Kelly Arkitekter

year: 2003

place: Gårdsten, Sweden

description:

The residential complex of panel buildings was built in the 1970s as part of the Swedish Million Programme (a program to build a million new homes). Revitalization of the entire neighbourhood, aiming to address the problematic district and inadequate housing, began at the end of the twentieth century.

Apart from creating better conditions within individual housing units and adding communal spaces, particularly greenhouses, the designers significantly focused on energy solutions, potential savings and sustainable ways to obtain them. The roofs of the buildings were equipped with solar collectors to heat water, especially in the new communal laundries. That allows significant energy savings. As new residents move in, the costs of acquiring their washing machines are reduced. These machines are selected for efficiency and energy use, making the entire technology as environmentally friendly and efficient as possible. A uniform hypo-allergenic laundry detergent is used and dosed according to the weight of the laundry load. Double-layered façades regulate extreme temperature fluctuations in both summer and winter months. They also provide space for balconies and winter gardens. Ventilation operates through a chimney effect across all floors, with excess heat collected under the roof and subsequently utilized. Electric energy for a significant number of apartments is obtained from solar panels and wind turbines.

The waste collection system is communal, created for recycling all possible waste groups.

The concept of composting is divided into two categories. Either the waste is stored in a local composter and used as fertilizer by local greenhouses or, in large quantities, it is collected in containers, exported and further used to produce electricity in central power plants.

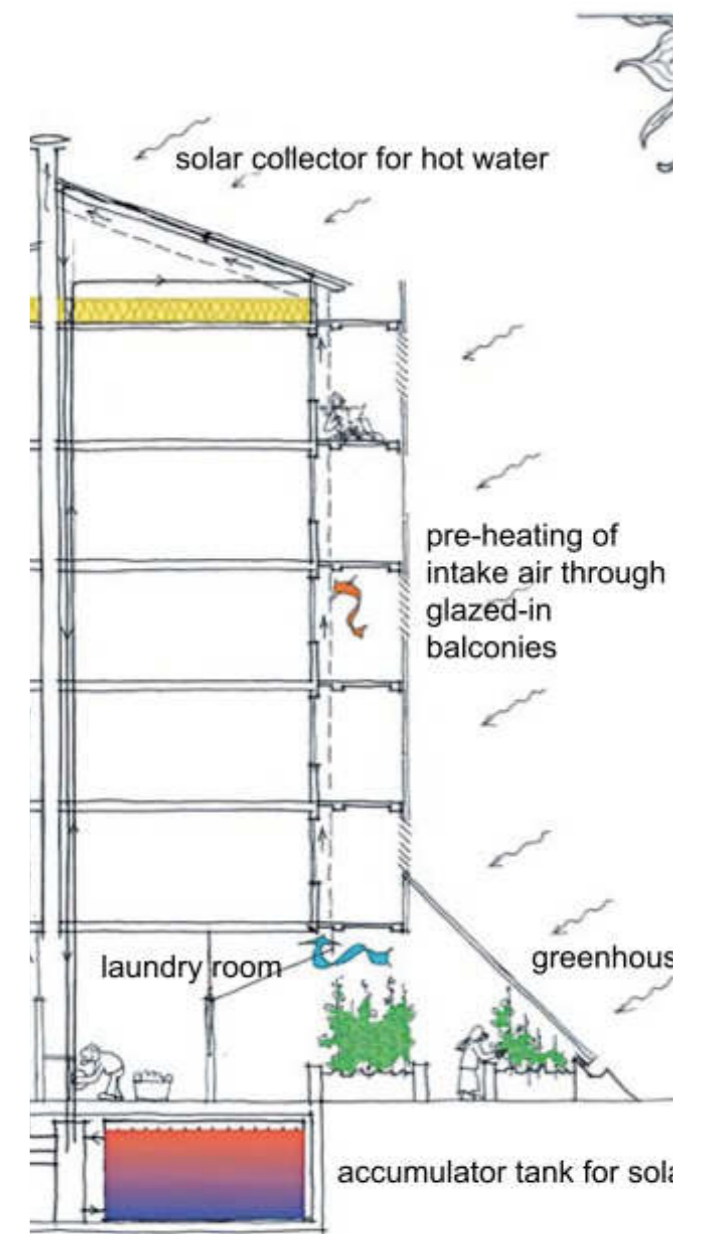
Diagram of energy cumulation and useⁱⁱ

Related publications:

- *Informační příručka pro vlastníky, správce a uživatele panelových bytových domů: technická podpora programu Panel. Praha: Informační centrum ČKAIT, 2002. ISBN 80-86364-94-1.*

common spaces

S

- in most cases, the ground floor is dedicated to communal functions
- staircase halls are designed very simply and cleanly, avoiding wasted space
- the buildings are equipped with elevator

- not very representative.
- common functions (laundry room, drying room, community room, etc.) are no longer used
- lack of potential for building a community.
- in many cases, the common areas of panel buildings are neglected

W

- unused spaces can be re-purposed for community purposes, such as converting ground floor areas and rooftops
- common areas can be transformed for commercial use
- some unused spaces can be allocated as additional storage areas

- inappropriate choice of new functions - noise...
- little consideration for community preferences
- poor interventions in terms of the specific environment's needs
- inappropriate selection of the form of community function (it may become exclusive)

O

Common areas of residential buildings have great potential in fostering community and neighbourly relationships. The psychological effect of these spaces plays a significant role not only for the residents of a particular building but also for visitors. If residents develop a sense of attachment to their home, they are more likely to take care of the shared property and less likely to neglect it. Common hallways and vertical communication spaces should be inclusive, accessible to all, and safe for all groups of residents.

Community-building takes place both in common hallways and in social spaces or private areas on the roof. Outdated functions, like laundry rooms and other amenities, can be replaced with shared spaces, sports activities, multi-purpose halls, and other social functions.

Opening these spaces closer to the public can bring a different quality of life. Connection between the common spaces of buildings and the exterior is often more than desirable and can help revitalize the entire area.

When it comes to renovations of exclusively shared connecting spaces in panel buildings, it usually involves replacing elevators or adapting spaces for barrier-free use. Often, there is a need to replace the walking surface layer of floors or inadequate railings. During these interventions, the historical structure and detail are often suppressed. They do not stem from the knowledge of the specific type of panel building and can appear austere.

Practical necessities are the main topic of all common connecting spaces. Fire safety requirements must be met, including the dimensions of spaces and materials used. Fire-prevention equipment must be

present in common hallways, along with water, gas, and electrical shut-off valves.

The interiors of these spaces are influenced not only by the choice of colours and materials for floors, walls, and ceilings but also by the selection of all equipment from lighting to doorbells for individual units.

The ground floor of both residential and non-residential buildings has the potential to contribute to urban development and create a relationship between the built and open spaces, between private and public, and between residents and passers-by. Direct connection to public space brings many opportunities but also challenges. Poorly articulated boundaries reduce the orientation in the area and the legibility of the locality, including the building itself.

The ground floor of a building conveys numerous pieces of information through door and window openings and the used materials. However, in the case of panel buildings, their façades are often not articulated.

Ground floor spaces in panel buildings are often underutilized, offering the potential to create new job opportunities and enrich public amenities. Commercial use proposals must be in close contact with the local community needs. Small shops, cafés, or bistros can be created in more urbanized areas. Co-working spaces may work well in quieter residential areas. It is also possible to create communal spaces on the ground floor specifically for residents. If these spaces also function as foyers for individual homes, there is potential to revitalize the area as a whole and increase its attractiveness.

T

Renovation of Le Lignon

author: Jaccaud Spicher Architects Associés

year: 2021

The architects approached the revitalization reverently and preserved the construction details in their original state. The façade was insulated, and window and door openings were replaced.

The façades are livened up with differently coloured internal shading blinds of window openings. Slight adjustments were made to the layouts and furnishings of individual units. Access spaces to individual sections and internal common connecting spaces are equipped with new door openings and small details have been replaced.

The stone cladding of the walls in the outdoor entrance areas has been preserved, wooden ceilings have been repaired, and the original design of individual entrances has been retained as well. Internal staircases have been replaced, in some cases, with monolithic concrete arms transitioning into concrete screeds on adjacent walls. The floor of the corridors is made of blue epoxy screed, complemented by blue metal door frames with wooden and chrome details.

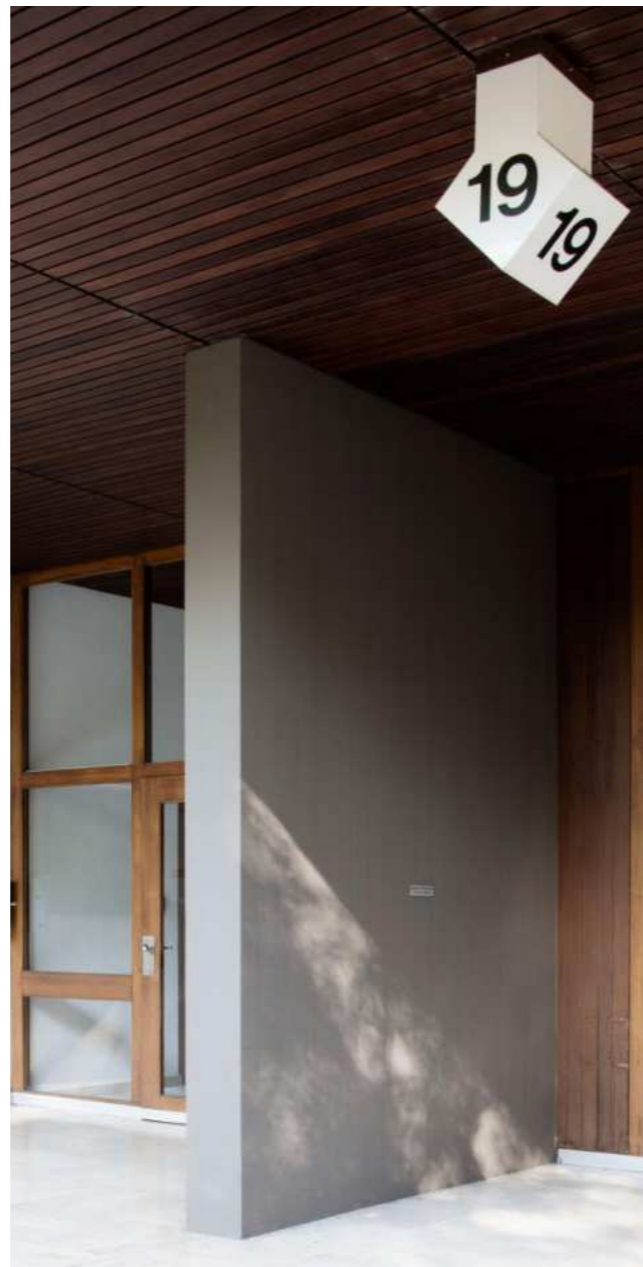

Stone cladding and wooden roof in the entrance areaⁱⁱⁱ

JACCAUD SPICHER ARCHITECTES ASSOCIÉS RENOVATION OF LE LIGNON. Divisare [online]. 2022 [cit. 2024-01-22]. Dostupné z: <https://divisare.com/projects/455289-jaccaud-spicher-architectes-associés-paola-corsini-joel-tettamanti-renovation-of-le-lignon>

Park Hill - Second stage

author: Mikhail Richies, Alumno Development

year: 2019, 2022, continuing

place: Sheffield, Great Britain

description:

Park Hill is an extensive residential complex in Sheffield, built in the 1960s. The individual apartments are accessible from wide walkways lined with façades made of massive brutalist concrete elements. The revitalization of the complex began in 2019 and consists of several phases.

Many new public functions, including a nursery school, student residences, office spaces, and dining establishments, are proposed within the complex. The apartments have been adapted to offer inclusive standards and are intended to serve a wide range of age groups of residents.

The second phase, designed by architect Mikhail Richies, features subtle shades of colours used both on the façade and to enliven the common spaces of the walkways. The original raw concrete details have been preserved, supplemented by entrance frames to private apartments in pastel colours and colour-coded sections. New floors draw inspiration from the original mosaic tiles.

Mikhail Richies restores „original beauty“ of brutalist Park Hill estate in Sheffield. Dezeen [online]. 2024 [cit. 2024-01-22]. Dostupné z: <https://www.dezeen.com/2022/12/15/mikhail-riches-park-hill-estate-sheffield/>



Colourful apartment entrance doorⁱⁱⁱ



Main entrance hall^{iv}

New established entrances^v

Enschedelaan

author: Vanschagen Architecten

year: 2003

place: Den Haag, Netherlands

description:

The transformation of existing buildings has created new social housing, providing accommodation for both families with children and seniors. The layouts of the houses have been modified to meet the specific needs of families with larger numbers of members and seniors requiring greater accessibility and access to medical care facilities.

The ground floor has a new connection to the public space of the street, with emphasized entrances to the buildings. The spaces between individual buildings now serve as front gardens for the units located on the elevated first floor. Play elements for children have been installed in these areas, along with seating areas, providing spaces for children to play and for neighbours to meet. By separating the internal courtyards from the public space, an outdoor space has been created that forms a community, is controllable, and has been significantly revitalized.

Private playground within courtyard^{vi}

Commercial ground floor Praha Háje

author: -

year: -

place: Prague, Czech Republic

description:

Despite the potential for use of the ground floor spaces in panel buildings for commercial or other purposes, such implementations are rare in the Czech Republic. Occasionally, individual shops are established in former drying or laundry areas within housing estates. However, these are not part of a conceptual design or an effort to cultivate and enrich the surroundings but rather to fulfil a specific agenda for personal gain.

An example where commercial activity thrives on the ground floor of a panel building can be found in the vicinity of Háje metro station. I don't want to present this space as a perfect or sole solution, nor as a model to be followed. Instead, I aim to illustrate a place that, despite its imperfections, serves as a meeting point for residents returning home from work, and those wanting to buy things they've forgotten to pick up in town for dinner. The elderly from nearby areas come here for puzzles from the news-stand or use the nearby hairdresser.

Interventions in these spaces pose various challenges, but they can create natural focal points and contribute to easier orientation within the area.

Panel houses close to Háje metro station^{vii}Commercial ground floor^{viii}

S

- non-load-bearing partitions are easily removable
- residential units have sufficient floor space according to their standard
- most of the residential units have a balcony or a loggia

W

- layouts are constrained by the narrow module of load-bearing structures (3.6m)
- inadequate bathrooms and kitchens, particularly due to their minimal spaces
- difficulties in furnishing and a lack of storage space
- very limited range of standards (variability)

- combining/dividing existing residential units to create a broader range of standards (leading to the diversification of the population in the area)
- offering modern variable housing that adapts to individuals (individuals don't have to conform to a fixed view of housing)

- individual and uncoordinated interventions degrading the structural integrity of the entire building
- limited variability in creating a monotonous group of residents
- the worst-case scenario could lead to the creation of excluded areas

O

The layout of apartment buildings and consequently their units are highly individual. Currently, there is a loosening of the traditional perception of living. Numerous new experiences, situations, and fundamentally changed ways of working and spending free time have entered people's lives. The home not only provides a place to rest and store personal belongings but also serves as a venue for work meetings and social gatherings. People can connect with the rest of the world from their living room using computers or other devices.

Given the nature of all these changes, it is evident that our understanding of living is still very rigid and requires new approaches in its design.

The revitalization of interiors in individual apartments in panel buildings is one of the most common interventions in these buildings. Numerous examples of successful projects exist.

The standardized construction and strictly defined modules of panel buildings bring many problems. The narrow module-reinforced concrete walls and poorly resolved details are problematic when creating new openings or making changes. However, if the strict rhythmic structure is accepted and respected there is a potential to create a modern space with contemporary standards.

For most interventions, it is necessary to maintain the position of load-bearing panel walls and the apartment core. It is necessary to address poor sound insulation of both vertical and horizontal structures. Poorly designed storage space is a problem. It is challenging to install new technical installations in panel walls. An option is to create special structures for them, such as false walls or lowered ceilings.

T

Vertical structures are often covered with layers of old plaster or paint. These visual layers may have significant defects due to the poor foundation of the building the consideration of the inaccuracies is crucial during repair or replacement.



The main living area with connected winter garden^{lx}

Hnízdo

author: Ateliér Tvary

year: 2020

place: Ostrava, Czech Republic

description:

The interior renovation project transformed the former 3+1 apartment in a panel building into a 2-room apartment. The apartment is intended for two people. It includes a separate workspace, a wellness area with a Finnish sauna within the bathroom, and the main living space connected to a winter garden.

The designers removed non-load-bearing partitions, leaving only the load-bearing panel structures. The dividing elements separating the main living area and the workspace are made of brushed plywood panels.

The winter garden features a wooden platform floor, which serves as storage space, and a seating area and contains a bed in the main area. Built-in closets are placed along the walls adjacent to neighbouring apartments, assisting with sound insulation.

Necessary installations were routed into the false walls, and new floor structures were implemented to improve sound insulation properties.

The main living space and office are connected by a translucent glass partition, and can be shared with sliding wooden panels. The apartment space is bright, spacious, and warm due to the use of wood.



The placement of sleeping area^{lx}

12 meters long apartment

author: RDTH architekti

year: 2020

place: Prague, Czech Republic

description:

The design team transformed a former 3+1 panel apartment into a 3-room apartment with a spacious main living area, which gains variability through the possibility of partitioning with a textile curtain.

Non-load-bearing partitions were demolished, and the original particleboard core was removed. The newly created main space expands from one longitudinal façade to the other and spans a length of twelve meters. There is an entrance to the master bedroom in the living room area, while the part dedicated to the dining table provides access to the children's room. The kitchenette is in the middle of the layout, adjacent to the wall adjoining the new bathroom.

Storage spaces are provided within built-in closets. The entrance hall space is connected to the main living area, while the entrance doors are framed by a system of closets.



A look through the kitchen to the dining area<?>



The living room area with an entrance to the master bedroom<?>

Related publications:

- BECH-DANIELSEN, Claus, Mette MECHLENBORG a Marie STENDER. WELCOME HOME Trends in Danish Housing Architecture. 1. Slovenia: Politikens Forlag, 2018. ISBN 978-87-400-4188-0.
- POSLUŠNÁ, Iva a MEIXNER, Miloslav. Moderní panelový byt: [nápad, úprava, řešení]. Brno: ERA, 2007. ISBN 978-80-7366-108-3.
- RAMSTEDT, Frida. Manuál stylu a designu pro každý domov. Přeložil Lucie OLEŠOVÁ. Praha: Metafora, 2020. ISBN 978-80-7625-097-0.
- DULLA, Matúš. Kapitoly z historie bydlení. V Praze: České vysoké učení technické, 2014. ISBN 978-80-01-05433-8.
- PANELOVÝ BYT V PŘEROVĚ. Komon architekti [online]. 2024 [cit. 2024-01-22]. Dostupné z: <http://komonarchitekti.cz/projekt/panelovy-byt-v-prerove>

4.

System T06B
qualities and potentials

	layout solution	technical condition	aesthetic aspect	urban aspect	
current values	<ul style="list-style-type: none"> · corresponding m² to the housing unit standard · clean layout of rooms, linked to the module · minimized areas of common halls, economical vertical communication 	<ul style="list-style-type: none"> · clear diagram of the support system · stable construction · suitable spaces for the necessary technical background 	<ul style="list-style-type: none"> · clean lines, rhythm · work with dividing the surface of the facade using horizontal and vertical lines 	<ul style="list-style-type: none"> · sufficient space for various events · trees and other vegetation · potential to create a community interact with many different people 	current values
ideal future development	<ul style="list-style-type: none"> · inclusive (for a wide range of population groups) · modified room layout - ergonomic space · efficient use of private and common spaces · more flexible 	<ul style="list-style-type: none"> · the load-bearing wall system is an opportunity, not an obstacle · integration of environmentally friendly procedures and technologies · economic and ecological handling of commodities 	<ul style="list-style-type: none"> · based on efficiently used spaces · „noble“ materials create different atmospheres and convey different information · variation of the rear monotonous facade linked to newly proposed functions (disposition) 	<ul style="list-style-type: none"> · objects communicate with the environment · functions in the interior of the ground floor use the exterior spaces (they complement each other) · the public space offers a range of spaces connected to the buildings 	ideal future development

In many cases, we are accustomed to viewing panel construction with negative associations. Many people associate panel buildings with the undesirable tinge of totalitarian regimes, while others see layers of ideas and judgments that have been allocated to panel housing over the years. Panel buildings certainly have many objectively negative qualities that need to be addressed. However, they also have many positives. Searching for these positive aspects can help us understand which parts of the structure and processes to preserve during repairs and interventions and what to build upon. By recognizing their strengths, we can navigate effective solutions to potential problems.

Each quality carries the potential for further development and building upon in the future. To describe these qualities, I have divided them into four groups, listing the qualities derived from previous research. I am sure that despite my efforts to approach

this description as objectively as possible, qualities, especially in the group of aesthetic characteristics, are partly subjectively coloured. Nevertheless, they represent points for reflection and consideration on how to deal with different topics. For each quality, I further provide its potential future development.

In terms of floor plan design, I perceive the positives primarily in their clear layout. Thanks to a strict module, simple layouts without unnecessary nooks, alcoves, and “residual spaces” are achieved. Shared corridor spaces are minimized, not taking up valuable space dedicated to apartments and other utility functions. While the apartment units are small, their area usually corresponds to their standard. Many of the apartment units have at least a small balcony. Smaller apartments have a loggia placed on the staircase mezzanine.

Buildings are characterized by a simple scheme, also from a technical point of view. Structural strength is achieved through the interaction of load-bearing panel walls and ceiling slabs. Lateral stiffness is achieved through walls in the opposite direction. Technical infrastructure installations are utilitarian and assembled into systematically located technical shafts with outlets on flat roofs. On the technical floor (whether at the entrance level or on the first underground level), there is sufficient space for technical rooms with the possibility of expansion for the installation of any new equipment.

From an urbanistic perspective, I seek qualities mainly where there is a potential for future development. The debate on the urban form of panel housing estates is currently lively and extensive. Regarding individual buildings, I see potential mainly in the ample space around them, which provides opportunities to enrich the area with new qualities.

Given the time of their creation, housing estates now contain a significant amount of mature tall greenery, the cultivation of which can achieve very favourable results in a relatively short time. Trees that have been growing for fifty years cast far more shade than those we just planted...

I see aesthetic qualities primarily in the clean lines of the façade. The “T06B” system is very diverse. Many implementations use a consistent parapet envelope complemented by windows with insulation inserts. Spatial profiling and the use of different materials lend the façade a unique appearance. Other elements creating strict rhythmicity are the horizontal bands of balconies and loggias with many variations of railing solutions. In cases where these elements are used on a less extensive apartment building, the elements complement each other in a harmonious whole.

4.

System T06B
problems and limitations

	problems	possible solutions	building insulation	extension	replacement of the facade	acoustic cladding	front wall	current distribution systems revision and revitalisation	new technical concept	roof revision and revitalisation	elements generating energy	new green roof	roof extension	new interior shading system	new exterior shading system	alternative apartment layouts	merging/dividing apartment units	revitalization of bathroom cores	expansion of common equipment	custom storage system made specifically for TO6B	new/improved storage within the entire building	new common spaces	new commercial spaces	new social spaces	common rooms revitalisation	building accessibility increase	different facade material on the parter level	new exterior functions aligned with parter spaces	articulation of the nearest public space
technical aspects	thermal insulation		● ○	● ●	● ●					●																			
	acoustic				●	● ●				●		●								●									
	technical distribution systems					● ●	●		● ○			● ●						●											
	roof (structure/use)							●	●	● ●	● ●	● ●	● ●	● ●						● ●	●								
	shading elements			●	●									●	● ○	● ○													
	economic aspects		●	●	●				●	●	●	●		●	●				●					●					
layouts	inadequate apartment standards			● ●								● ●					●												
	inadequate hygiene equipment							● ○						● ●	● ●			● ●	● ○										
	inappropriately arranged room sizes			● ●		● ●										● ●	●												
	difficult furnishing of apartments					● ●	● ○									● ○	● ○			● ○									
	lack of storage space															● ○	● ○			● ●	● ○	● ●							
	unused spaces of laundries and dryers																	●				● ●	● ●	● ●					
	neglected entrance areas and common corridors																					●	● ●	● ●	● ●	● ○	●		
	common spaces do not support community building											● ●	● ●							● ●			● ●	● ●	● ●				
	lack of communication between the building and the surroundings	●	●	●											●	○				●			●	●	●		● ○	●	● ●
urban aspects								● ○								● ●			● ●			● ●	● ●	● ●		●		● ●	●



private apartment owners. All interventions must be discussed and approved by this committee. The financial cost and very different individual visions play a significant role. Complete revitalization of a building, involving a review of existing apartment units, façades, common areas, and surroundings, is very rare in the Czech Republic. Usually, there are examples of partial work within the entire building, and more drastic interventions take place only within private apartment units. Therefore, I also offer solutions that correspond to this situation but are at least to some extent systematic so that it is possible to build on them in the future if the financial situation changes, another problem needs to be addressed, or if there is potential to introduce a new function.

From a technical point of view, problems mainly occur in thermal and sound insulation, which is inadequate according to today's standards. Most "T06B" system buildings were completed before the introduction of the new thermal-technical requirements "NKS," so they are in a worse position than younger panel buildings completed in the Czech Republic. The easiest solution in this case is to add an insulation layer, both thermal and soundproofing. However, this solution comes with certain pitfalls, not only in terms of thermal-technical but also aesthetic aspects. Therefore, I will address it in more detail in the next part of this work. Another complication is the outdated technical infrastructure system, which does not allow the use of modern technologies to reduce negative impacts on the environment and the energy demand of the entire building. This issue is also related to inadequate bathroom cores. They are designed with minimal dimensions that no longer meet current requirements. Revitalization of bathrooms is possible in many cases only if there is at least partial intervention in the concept of technical management. Another element I address in the technical part is roof solutions especially inadequate layer composition and untapped potential. In cases where there is no willingness or potential for at least partial use, I propose the layer composition revitalization, insulation, and placement of extensive greenery as a new quality. There are countless possibilities for further interventions within the roof, and I will list them on the following pages.

Interior shading proves to be a comprehensive topic, especially in the building's economy and achieving a pleasant internal microclimate as simply as possible. Most panel buildings have a well-chosen orientation towards the cardinal points. However, the steadily rising temperatures in the summer months in our area necessitate a broader solution to building overheating. The most effective solutions are shading elements located on the exterior. However,

their appearance significantly affects the façade aesthetics and the appearance of the entire building. Therefore, their design requires careful consideration. If shading elements are designed effectively, they reduce the need for mechanical cooling of the interior thus the economic and environmental demands of the buildings.

I perceive problems in the layout of panel housing primarily in terms of uniformity and limited options. There is a limited number of standard unit types, which are machine-repeated almost endlessly. The problem is not so much in poor design, it's rather the problem of a very narrow selection, which can offer satisfactory solutions for only a small number of residents. Living is bound only by one interpretation. Apartments offer very little scope for individualization. The floor plan is tied to a rigid narrow module of load-bearing walls. Interventions within these walls are complicated and require expertise. For this reason, I carry out all interventions within floor plans based solely on extensive analysis of the static diagram of the entire building. I am trying to find multiple solutions corresponding to a wide range of standards for individual unit variants. All solutions are also differentiated according to the necessary extent of intervention. It is, therefore, possible to choose an option that offers only a change of partitions without any intervention in the load-bearing structure or one that releases the apartment floor plan to the greatest extent possible and adds projecting structures for its expansion. Enrichment of the existing housing offers inclusive spaces within existing housing units but also the addition of extensions or rooftop structures. In this case, it is possible to take the constraining static module further and work with it differently using current materials, which offer different possibilities. However, all added structures are considered from prefabricated components. They are far more variable and with the possibility of disassembly and further use. Prefabricated components have great potential in terms of long-term sustainability and the overall life cycle of the building. Modular constructions offer the possibility of easy replacement of damaged elements or parts of the building with lower durability. In newly created structures, I try to place high-standard housing units or facilities offering options for a wider range of residents.

Existing spaces of former laundries with dryers located on the ground floor are currently unused. The proposal for their use can address many problems especially inadequate public amenities, connection between interior and exterior, and a lack of pleasant, shared space. The obstacle again represents the narrow module between load-bearing walls, which limits space and binds the potential of newly designed

functions. On the other hand, the significant advantage is the possibility of almost arbitrary modifications to the non-load-bearing façade. The variability of shared or newly proposed public or commercial spaces can be increased by adding extensions at the ground floor level. Opening the façade with larger openings will enrich the connection between the building and its surroundings. For variability of the first above-ground floor, I consider a reduction in cellar bays and providing more space for new functions. This solution is possible above all when there are designed higher-standard housing units with an adequate amount of storage space within the apartment. Or in the case of shared living, where extensive storage spaces outside the apartment are not used to such a large extent.

I primarily observe problems on an urban scale near residential buildings. The most pressing issue is the limited articulation of public space around panel buildings, which often leads to a situation where the hierarchy of spaces is not discernible. Another missing element is the connection of the building itself with its surroundings. Buildings are often uniform and similar. They do not convey the necessary information and make orientation in the area difficult.

I began to focus on the future of panel buildings due to my interest in interventions in existing structures, and panel buildings provided an opportunity to address a wide range of buildings with similar characteristics and problems. The table on the previous page attempts to objectively classify the problems arising from individual building parts analysis and subsequently find solutions for them. Each problem has multiple solutions and each solution addresses multiple problems. For easier navigation, I have divided possible solutions into six groups based on the area where the solutions to these problems manifest. Therefore, it's possible to search directly for a solution to a specific problem. Potential problems that a given solution will improve or how best to intervene in a particular area. For example, if the building needs to increase sustainability, it is possible to identify from the table what steps can be taken in what areas.

Initial problems are divided into three categories: technical equipment, internal layout, and urbanistic situation. They thus show a comprehensive picture of entire buildings and their main weaknesses. I then propose solutions to them considering the qualities and potentials mentioned in the previous chapter and considering existing references, which I list in the analysis chapter.

With this section, I would like to offer a wide range of solutions to the most pressing problems that can be combined to achieve the desired level of intervention. Any interventions on a larger scale than one apartment is difficult since most apartment units in panel buildings are now privately owned. In individual buildings, there is usually some form of homeowner's association representing individual

structure limits

possible new openings within load bearing panels

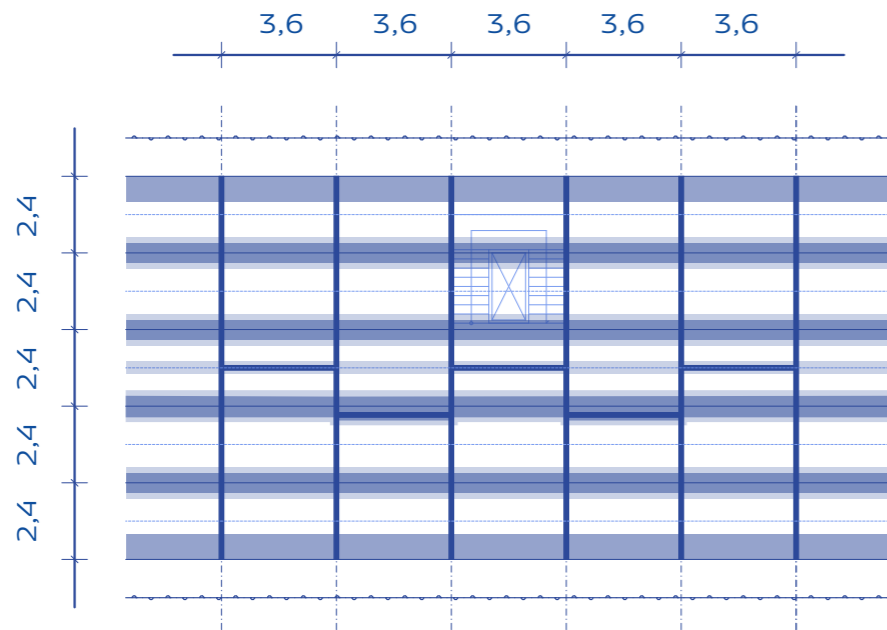

principle of placing new openings within one panel

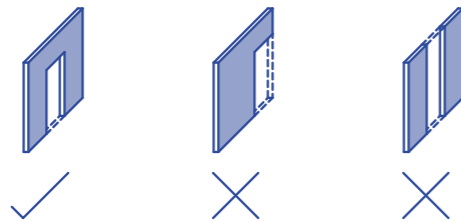

The basic principle that guides me in designing any intervention or modification is obtaining detailed information about the structural functioning of the entire building. Through the analysis of original drawings, system documents to produce individual panel elements, and consultations with a structural engineer, I have compiled diagrams that precisely identify critical points of load-bearing capacity and places where potential changes are possible.

The composition of structural elements within the building is relatively simple. Load-bearing panel walls are 12.0m long and 2.8m high. They consist of five identical panels with dimensions of 2.4m width, 2.8m height, and 150mm thickness. The structural elements of the ceiling are also prefabricated concrete panels with dimensions of 3.6m length, 1.2m width, and 130mm thickness. The entire building is supported by

structures composed of these two elements. Loads are transmitted to concrete foundation strips.

Interventions within the load-bearing wall panels are limited mainly by their width and the placement of ceiling panels. New permeation in load-bearing wall panels can only be created while adhering to specific conditions. An opening must always have sufficient lintel for load transfer from the ceiling. It cannot be located at the edge of the load-bearing panel. The minimum side column width is determined by the width of the opening. For openings up to 900mm in width, the width of the column is 300mm; for openings up to 1400mm in width, the width of the column is 500mm. Openings cannot be placed where the load-bearing panel meets the stabilisation panels; at least a 250mm wide column on each side of the stabilisation panel must be considered to

load bearing structures within typical floor

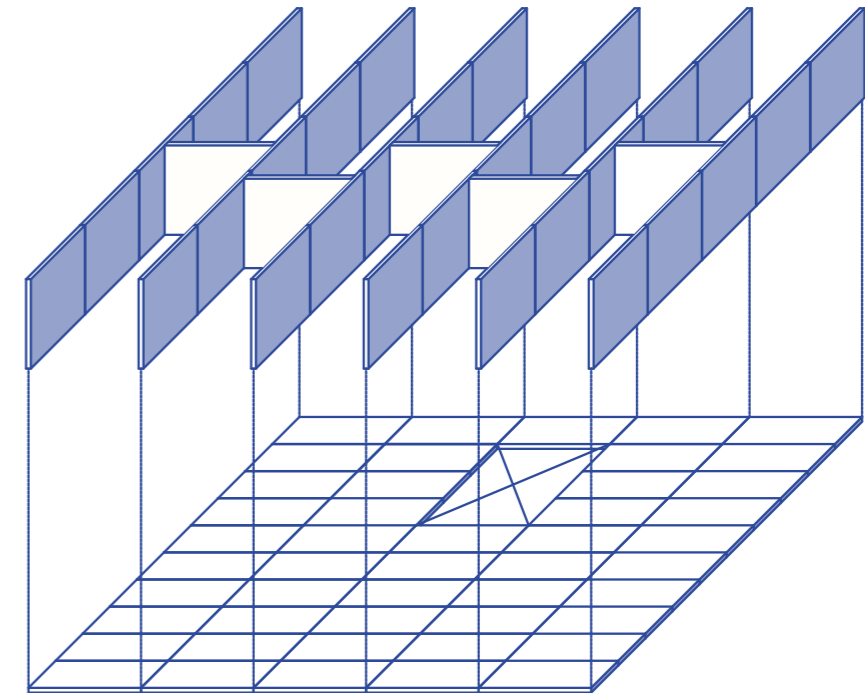

load bearing panel elements

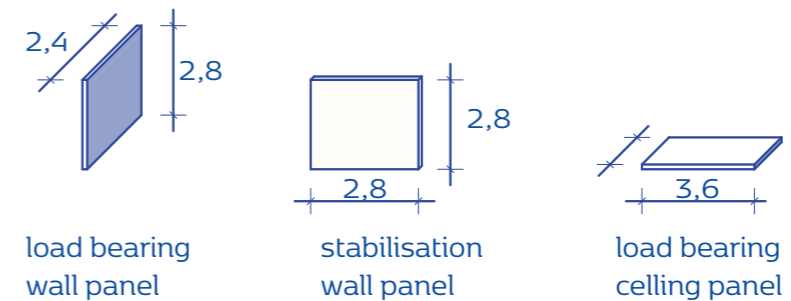

capture the force in the transverse direction without compromising the stability of the structure.

Interventions within the load-bearing ceiling panels can proceed in two ways. A larger opening, such as a newly designed staircase, can be created by removal of one-panel element. Additional technical passages must be placed ideally as close to the central axis as possible. If multiple openings are placed side by side, their orientation must be along the length of the panel; otherwise, there is a risk of compromising load-bearing capacity. It is not possible to create any openings in the middle of the load-bearing panel for its entire width and create a cantilever from existing panels. They are neither designed nor properly anchored for such loads, it would mean the structure collapse.

When designing new structures, it is possible to consider that each panel building has a load-bearing capacity with a reserve of about 15%. Increasing it for greater loads is problematic, and alternative structural support needs to be considered. When designing suspended structures, anchoring into both ceiling and wall panels simultaneously is necessary. The possibility of cantilevering new structures is difficult due to the small thickness of the ceiling panels. The limit for new projecting structures is a length of 1.2m.

5.

Proposals

facade

annex



exterior shading system



exterior insulation

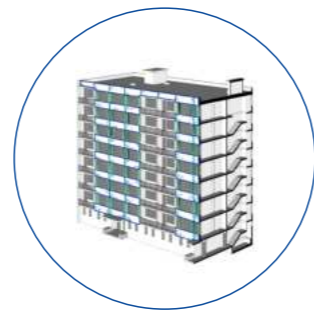

back facade variations

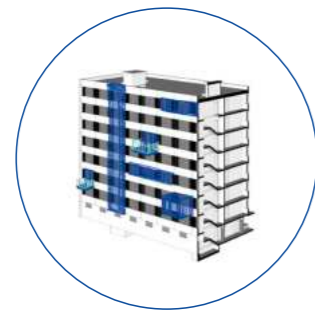

facade replacement

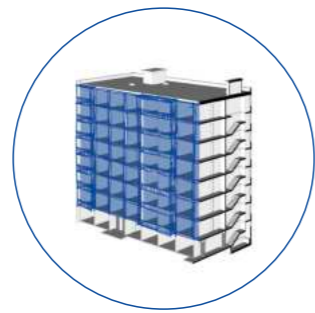

photovoltaic panels

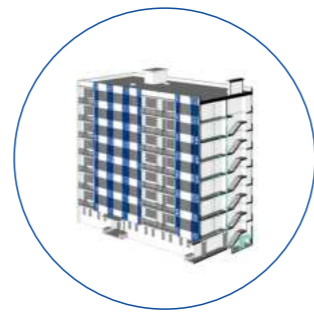

roof

green roof

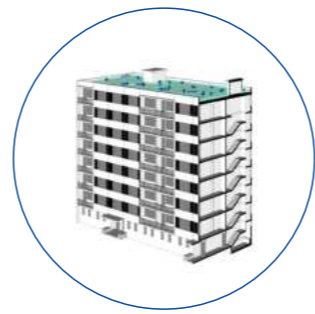

active roof



energy generators



extension/housing



extension/
community space



surrounding

surroundings articulation



new public functions



common spaces

extension

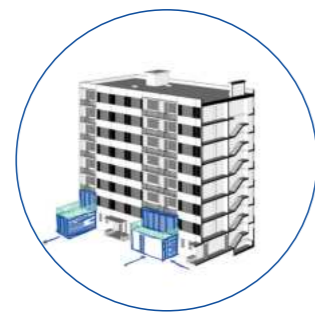

different material

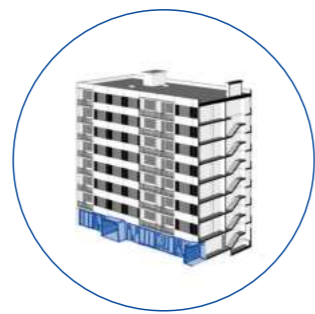

new community functions



new commercial functions



new social functions



layouts

alternative floor plan layouts

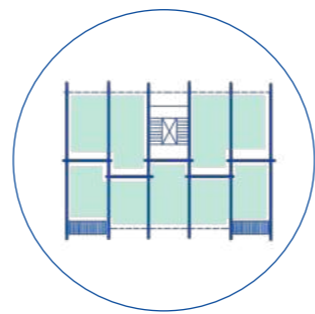

co housing concept

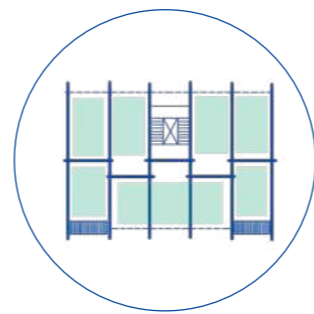

new overhanging structures

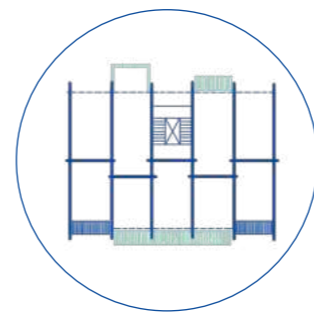

ending sections variations

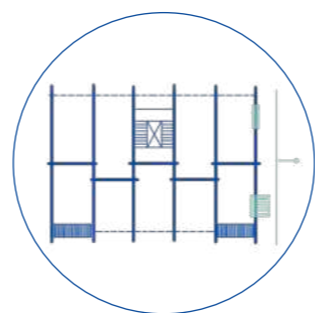

barrier-free solution

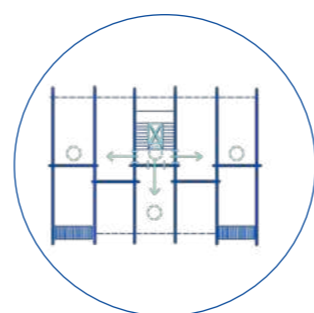

new public function

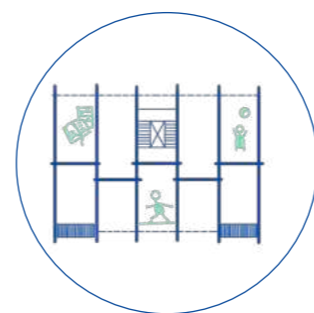

technical equipment

technical front wall

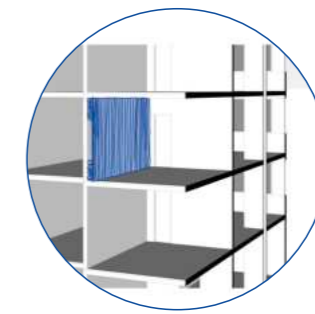

technical concept adjustment



distribution system revitalization

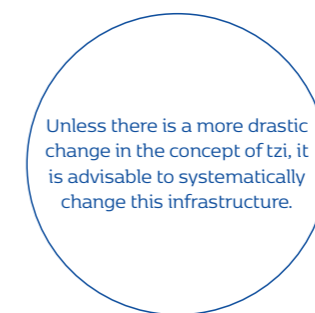

acoustic cladding



5. Proposals

The environment of panel housing estates is specific. Many examples attempting to address and resolve it show that it is a separate chapter that needs to be dealt with comprehensively and in various contexts. Even though my work primarily focuses on panel buildings, I believe a certain level of response to the surrounding environment is more than desirable.

I understand the building's closest surroundings, especially the connection of the events taking place in the house and their potential support and flow from the interior to the exterior. I fully realize that when intervening within a group of building projects coordination is necessary it is doubly true for public space. Through the solutions mentioned, I attempt to outline a range that can serve for discussion and be modified to local conditions and requirements.

For every publicly used project, it is important to determine the extent to which it should be specifically shaped and, conversely, the extent to which it allows for imagination and freedom of movement/decision for those who use it. An occasional excess of elements with which one can interact in public space makes it overly specific and prevents the emergence of any other events than those for which the space was designed. In some places, this is desirable, but in many, greater freedom is needed. Panel housing estates stand out with an opposite phenomenon. The free development of blocks within greenery creates large spaces that are difficult to grasp and lack any articulation and incentive to create any events. An excess of open space and possibilities ultimately leads to paralysis and to the fact that the space is not "inhabited".

The solution can be found in supporting the emergence of new public functions. In close relation to buildings,

this means creating spaces in the context of functions located within the building. Outdoor spaces that directly respond to the function indoors. Extension of the interior ultimately brings new value. Such places can represent a range from proven concepts such as a café terrace to a far more diverse range of activities. There can be a design for barbecuing activities in connection with a rentable community room, spaces for cultivation with facilities and storage spaces in the building, and space for hanging laundry in connection with a shared laundry room. The last option represents a kind of reminiscence of a function designed in the past, which is not used anymore in its original form. It is not suitable for everywhere and it requires a little more thought. It is necessary to support it with the design of shared and accessible housing and turn it into an advantage, not a negative feature. It would be utopian to think that everyone will use the shared laundry room and that there is no longer a need to think about space for a washing machine in family apartments. However, it is a place to achieve greater variability and offer different options and standards.

Other elements that can enrich the environment of housing estates and increase the value of individual apartments are spaces for relaxation, as well as children's play or sports. In some cases, it is not necessary to directly tie them to functions in the building. However, their relationship to it is highly desirable, and the proximity of such facilities can be a great advantage.

Thanks to the newly proposed elements, it is possible to cultivate and articulate the environment of the entire housing estate. This means making it more comprehensible and helping residents develop a closer relationship with the place they live. If residents feel good about their environment, their interest in the surrounding area and its maintenance and cultivation will increase. This is also related to social control, which is far more natural in places with human movement and contributes to a sense of safety and security.

5.

Proposals
surroundings

annex



exterior shading system



The environment of panel housing estates is specific. Many examples attempting to address and resolve it show that it is a separate chapter that needs to be dealt with comprehensively and in various contexts. Even though my work primarily focuses on panel buildings, I believe a certain level of response to the surrounding environment is more than desirable.

I understand the building's closest surroundings, especially the connection of the events taking place in the house and their potential support and flow from the interior to the exterior. I fully realize that when intervening within a group of building projects, coordination is necessary, and this is doubly true for public space. Through the solutions mentioned, I attempt to outline a range that can serve for discussion and be adjusted to local conditions and requirements.

For every publicly implemented project, it is important to determine the extent to which it should be specifically shaped and, conversely, the extent to which it allows for imagination and freedom of movement/decision for those who use it. An occasional excess of elements with which one can interact in public space makes it overly specific and prevents the emergence of any other events than those for which the space was designed. In some places, this is desirable, but in many, greater freedom is needed. Panel housing estates stand out with an opposite phenomenon. The free development of blocks within greenery creates large spaces that are difficult to grasp and lack any articulation and incentive to create any events. An excess of open space and possibilities ultimately leads to paralysis and to the fact that the space is not "inhabited".

The solution can be found in supporting the emergence

of new public functions. In close relation to buildings, this means creating spaces in the context of functions located within the building. Outdoor spaces that directly respond to the function indoors. Extension of the interior ultimately brings new value. Such places can represent a range from proven concepts such as a café terrace to a far more diverse range of activities. There can be a design for barbecue activities in connection with a rentable community room, spaces for cultivation with facilities and storage spaces in the building, and space for hanging laundry in connection with a shared laundry room. The last option represents a kind of reminiscence of a function designed in the past, which is not used anymore in its original form. It is not suitable for everywhere and it requires a little more thought. It is necessary to support it with the design of shared and accessible housing and turn it into an advantage, not a negative feature. It would be utopian to think that everyone will use the shared laundry room and that there is no longer a need to think about space for a washing machine in family apartments. However, it is a place to achieve greater variability and offer different options and standards.

Other elements that can enrich the environment of housing estates and increase the value of individual apartments are spaces for relaxation, as well as children's play or sports. In some cases, it is not necessary to directly tie them to functions in the building. However, their relationship to it is highly desirable, and the proximity of such facilities can be a great advantage.

Thanks to the newly proposed elements, it is possible to cultivate and articulate the environment of the entire housing estate. This means making it more comprehensible and helping residents develop a closer relationship with the place where they live. If residents feel good about their environment, their interest in the surrounding area and its maintenance and cultivation will increase. This is also related to social control, which is far more natural in places with human presence and contributes to a sense of safety and security.

5.

Proposals
facade

annex



exterior shading system

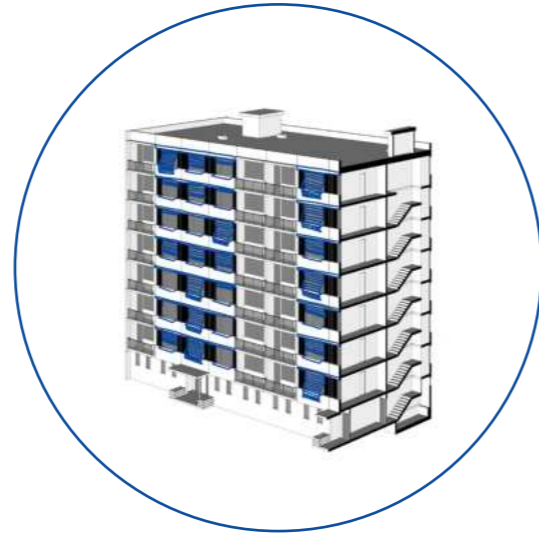

exterior insulation

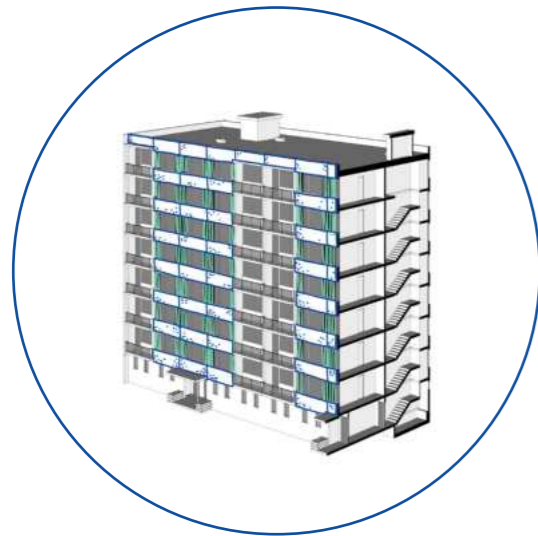

back facade variations

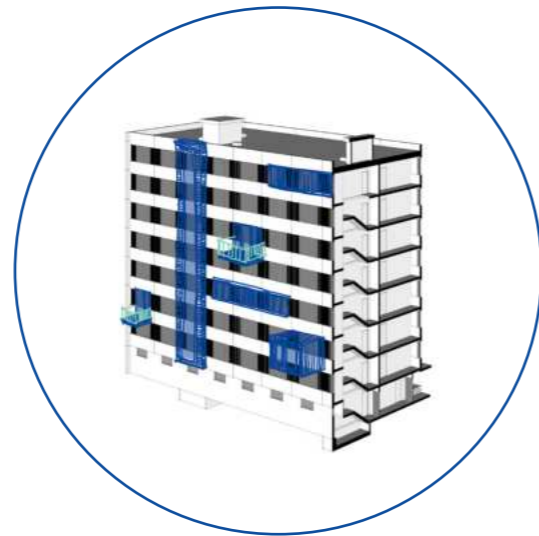

facade replacement

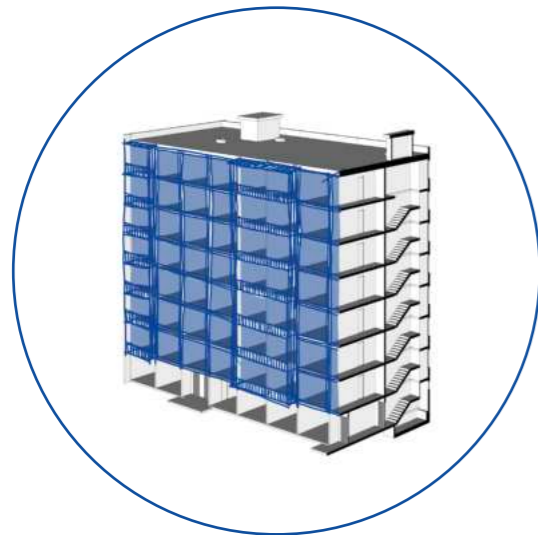

photovoltaic panels

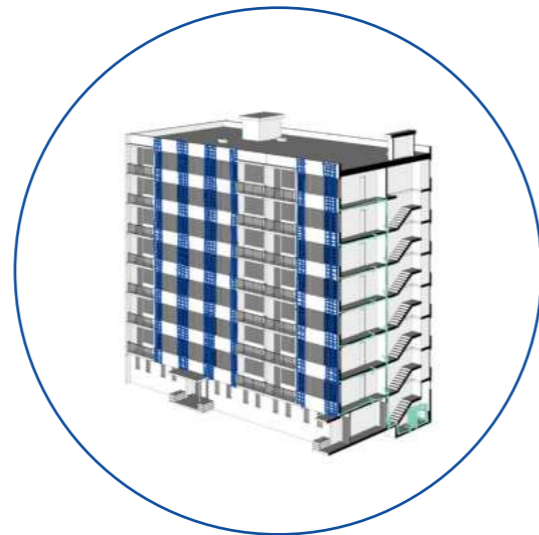

The façade of every building serves several important functions. Its task is to protect the interior from adverse weather conditions while giving each building uniqueness, and it significantly contributes to connection with the exterior. Moreover, it can be used for less traditional purposes, such as electricity generation, enriching the space with greenery in the form of climbing plants, and serving as an element facilitating orientation in the environment.

Through the proposed interventions, I aim to respond to a wide range of stimuli and potentials in the aforementioned areas. The most pressing problem of all panel buildings is the façade's thermal technical properties. The high demand for these types of work prompts the market to respond with standardized solutions, especially ones such as covering the entire façade with polystyrene panels and subsequently applying coloured plaster to differentiate the project from previous ones and make it "unique." Through the analysis of existing façade elements, their proportions, and interaction, I strive to show an alternative path. Concerning the current façade structure, it is possible to insulate only the strip of parapet façade panels and utilize the strip with windows and between window frames as an opportunity to follow the same principle. Replacing window openings and connecting them with insulation inserts made of a different material can give the façade a fresh, contemporary look while preserving its original structure. These principles can also be applied in the case of reconstructing only part of the façade; in such situations, it is advisable to select the materials for new constructions carefully.

The extreme solution for addressing poor thermal insulation problems is a complete façade replacement. In the case of the T06B system, this

option is quite easy from a static perspective, as the façade panels are self-supporting and do not contribute to the load-bearing structure of the entire building. This represents a significant change in the appearance of the entire structure, which can bring many benefits such as new and larger balconies or expanding existing layouts with annexes. It's essential to integrate with the local environment and consider the advantages and economic feasibility of the entire reconstruction.

A smaller intervention involves adjusting the size and layout of existing balconies. These modifications offer the possibility of expansion or additional features so that each apartment has access to an outdoor private space. Alternatively, new railing and shading solutions can enhance the façade.

Exterior shading elements are a way to mitigate the impacts of changing climates and shade heat entering the rooms, especially those facing south (or east and west). They can add another layer to the façade's design, enriching its complexity and repetitive element patterns.

It's possible to install energy generators on its surface if the façade orientation is towards the south (or east and west). These generators can be integrated into newly designed façade elements of thermal insulation, railing elements, shading, or balcony constructions.

When considering façade interventions, I am considering both the revitalization of the entire façade and only its parts. In the case of proposing new layouts with new projecting structures, I respect the façade's existing system of division and its current elements so that the proposed changes bring new value to both the exterior and interior and can be applied individually, in groups, or systematically. The rear façade offers space for more extensive interventions, characterized by evenly sized window openings with regular intervals. The frontal façade has window openings separated by a strip of balconies. Interventions on the frontal façade consider this division and explore opportunities for utilizing and expanding existing balconies.

5.

Proposals
roof

green roof

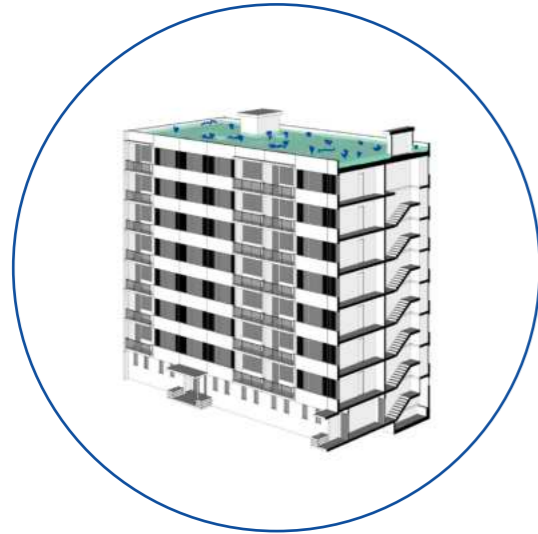

active roof



extension/housing



extension/community space



energy generators



bearing capacity of the existing structure. One floor extension can be considered within buildings up to six above-ground floors, while taller structures can bear two-floor extensions. Their supporting system is aligned with the existing building's structural system. In the case of extensions, I consider either social or residential functions. Their scope depends on the proposed content. I propose extensions serving as access to the newly created green roof with facilities for a small community room. Extensions in the form of greenhouses for plant cultivation are also possible. Full-scale extensions serve as lowered spaces for public and private events.

A separate chapter consists of extensions for housing with a higher standard of proposed residential units. In this case, I opt for an approach resembling a "family house" on the roof of a panel building. I aim to create private outdoor atria in the roof space and comfortable family living. Residential units are accessible from a common space with a new built staircase. They have the character of maisonettes or small family houses. The advantage lies in the view, privacy, and at the same time, the connection to the community and the benefits of living in an apartment building.

An important part of rooftop extensions is also consideration of the surface of their roof. In all cases of these extensions, I envision a roof covered with extensive greenery in combination with energy generators. I place photovoltaic or solar panels or wind turbines integrated into the proposed structures, which should contribute to the energy supply primarily for the newly created spaces.

I strive to address solutions for roof space in close connection with the static capabilities of the existing structure and technical feasibility within panel construction. However, I also aim not to keep in mind the aesthetic aspect. Since panel buildings of the "T06B" type are predominantly constructed as linear buildings, their roof forms the fifth façade, overlooked by point tower buildings designed in other parts of housing estates.

From this perspective and in terms of environmental and thermal-technical considerations, the first proposed solution is to create a new roof composition with extensive greenery. This is an (economically) feasible solution for which a few functioning references can be found. A green roof enriches the surrounding environment with a more pleasant micro-climate and significantly contributes to better rainwater management in the drainage area - retention and subsequent evaporation and air cooling. The composition can prevent heat loss through structures, and functions as insulation against excessive noise. Maintenance is minimal, and there is no need to create roof extensions in this case. An extensive roof is ideal in combination with photovoltaic or solar panels, which increase the self-sufficiency of the building. Although this combination is not permissible according to Czech building regulations, precedents can be found in foreign implementations, which already led to the mandatory use of this principle in extensive office complexes proposed within urban centres in some countries. Photovoltaic panels can also be integrated into the structures of designed extensions.

Extensions can be considered with a wide range of uses, their scope being conditional upon the load-

roof extension housing

static diagram

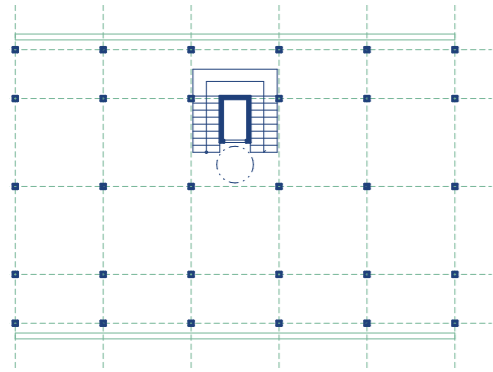

proposed units first level

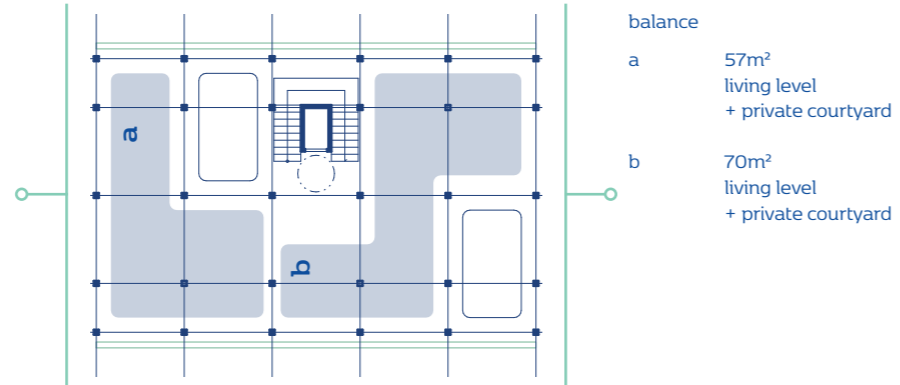

first level



- legend first level:
- 1 entrance hall
 - 2 laundry room
 - 3 living space
 - 4 kitchen
 - 5 private courtyard

proposed units second level

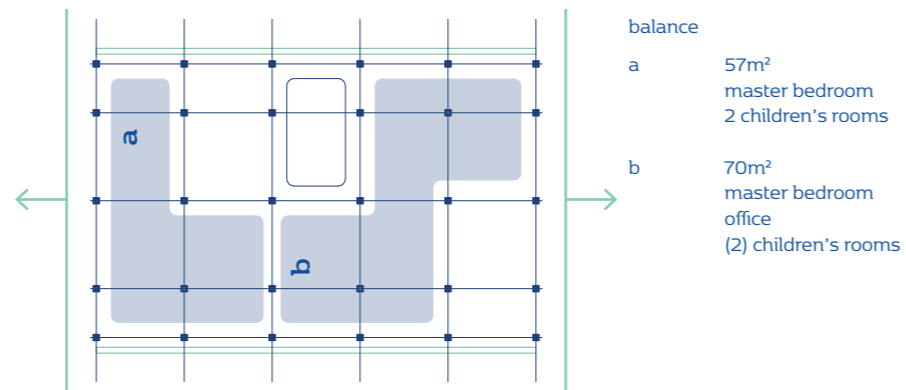

second level

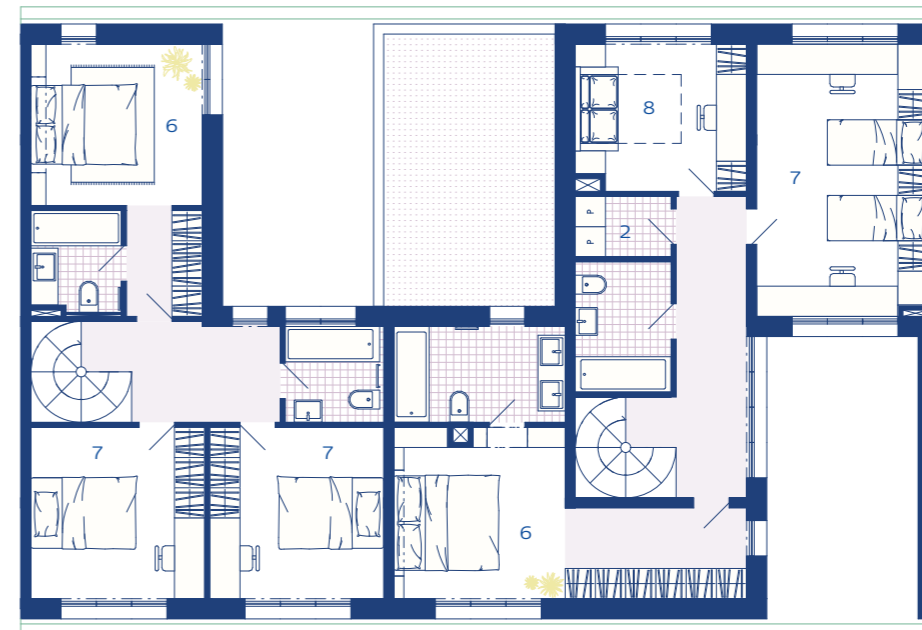

- legend second level:
- 6 master bedroom
 - 7 children's room
 - 8 office



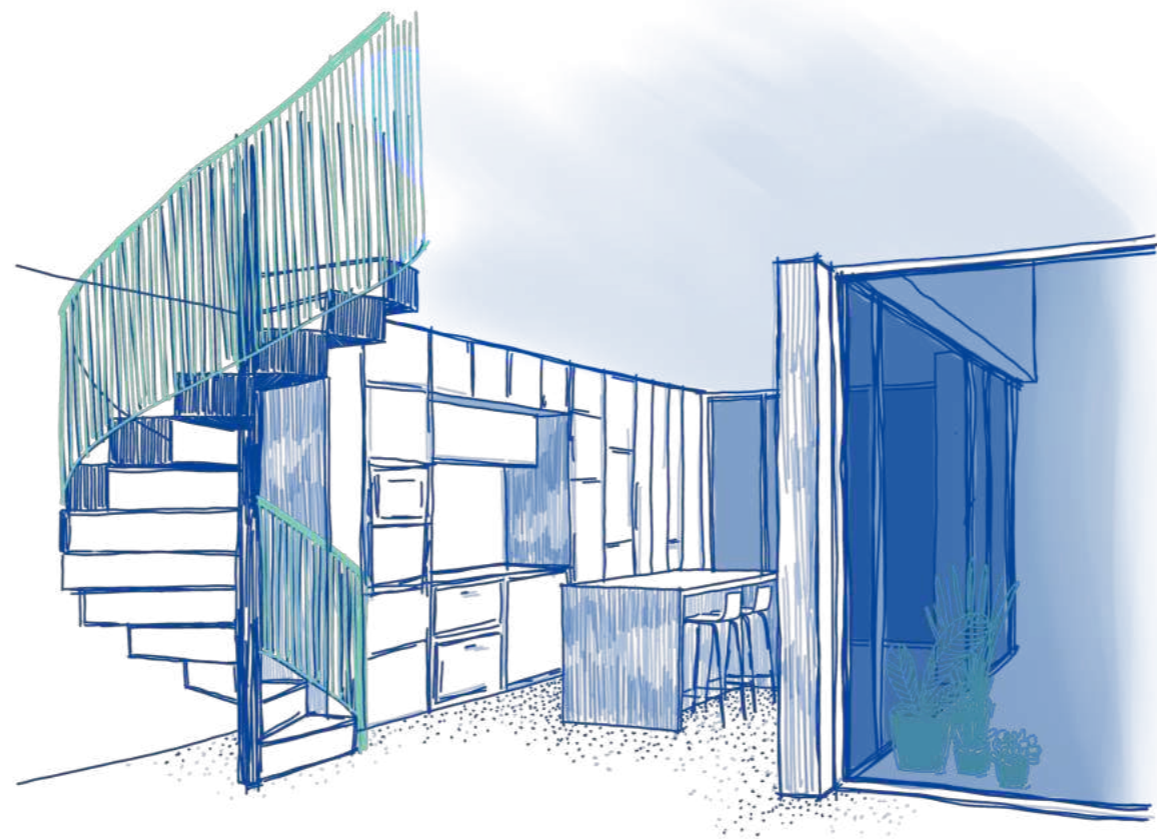

5.

Proposals

technical equipment

technical front wall

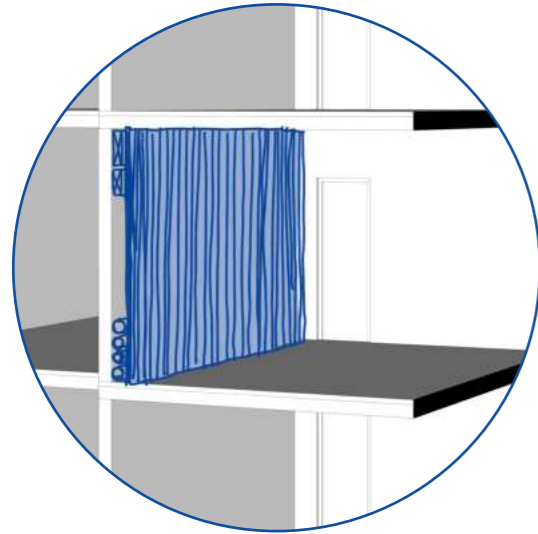

technical concept adjustment

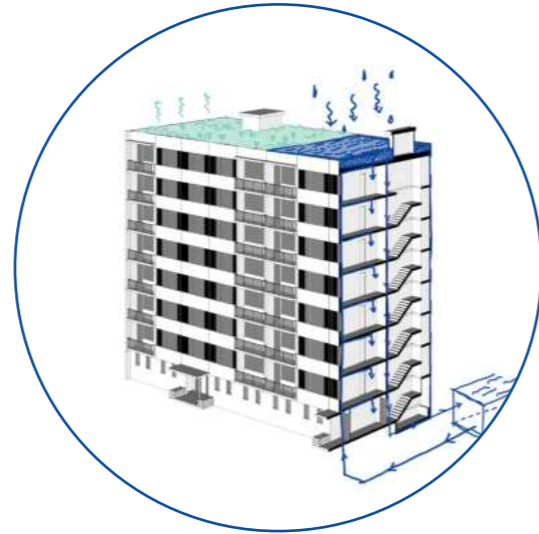

distribution system revitalization

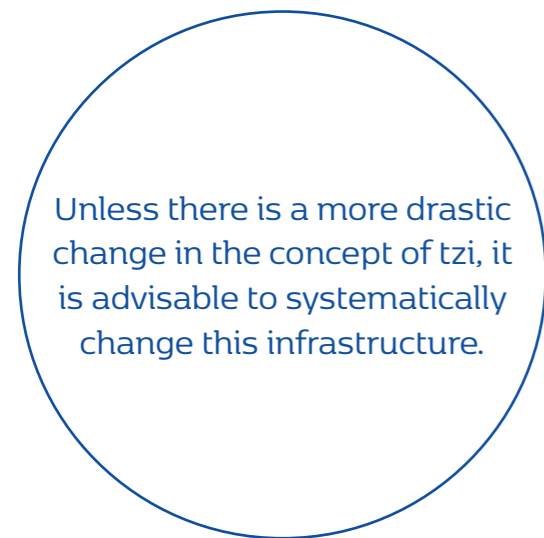

acoustic cladding



Systematic solutions to acoustic issues require specialist involvement. I aim to propose solutions primarily at the local level for specific cases. I suggest very simple interventions, such as placing wardrobe walls where the walls of two adjacent units meet. Partial soundproofing of walls can also be achieved using the aforementioned installation cavities. Soundproofing floor structures is more complicated, especially due to the relatively low floor-to-ceiling height. Local application of soundproof cladding may be an option, especially on the ground floor for new functions with earlier operation. It can also be used in apartments in music rooms or children's rooms.

A significant technical aspect of the entire building is its structural scheme. By analysing historical drawings and typical prefabricated panels, I propose interventions throughout the building to ensure there are no stabilizing defects or situations requiring additional reinforcement for stability. All interventions within openings in load-bearing structures, as well as added suspended structures and adjustments, follow a clear schema and are tied to the existing module.

I present proposals for possible technical solutions, primarily referencing existing implementations and technical analyses. The complexity of these issues requires close collaboration and expertise from specialists. For their correct, safe, and effective use, a special assessment is essential for each case and implementation.

One approach to increasing the sustainability and cost-effectiveness of the entire building is through a modified technical concept. Almost all panel buildings are centrally heated. Optimizing its use is possible through the installation of heat recovery systems. An important factor is water management. For apartment buildings, it is advantageous to consider reusing grey water from showers for flushing toilets or other secondary uses. This solution requires the design of retention tanks and a system for pumping and distributing greywater to its points of use. I propose retention tanks for rainwater as well. In urbanized areas, rainwater is often directed into common sewer systems, preventing further use. Retention tanks hold water, allowing for watering and possible infiltration into the ground. I propose rainwater retention tanks either on flat roofs or underground near the building.

The proposal for new technical infrastructure significantly affects the interior of the building. Running new pipes through concrete panel walls is challenging. One possible solution is surface-mounted technical conduits, or the creation of installation cavities hidden on the surface of panel walls. I try to place new conduits in existing utility shafts and newly designed partitions. I suggest floor penetrations at points of least stress on the floor slabs. In cases where more radical interventions are made, I add technical shafts for new utilities.

5.

Proposals

common spaces

extension

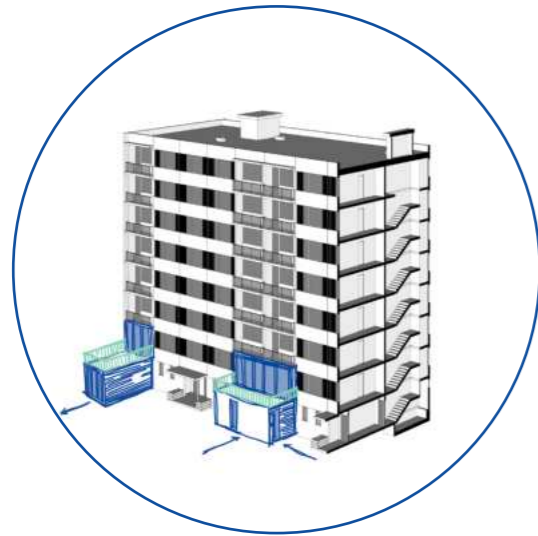

different material

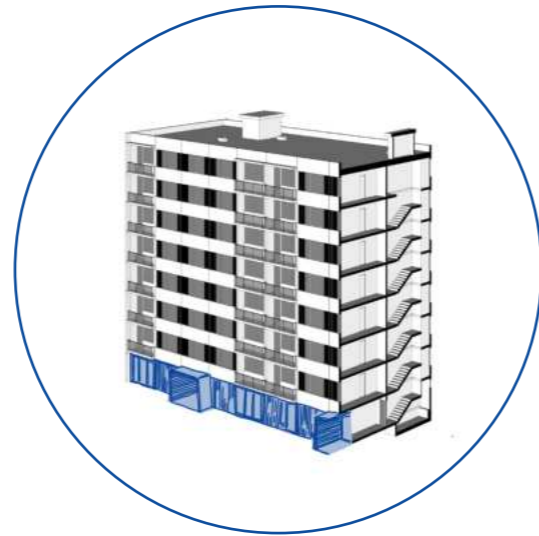

new community functions



new commercial functions



new social functions



I aim to find a wide range of uses and degrees of intervention when considering solutions for shared spaces. Detailed analysis of local conditions and identifying missing functions and qualities that will serve the residents well are necessary for their design in each implementation.

However, I do not limit possible interventions solely to the design of new functions and spaces. I consider entrances and common residential connecting spaces crucial parts of residential buildings. Therefore, I propose modifications to entrance doors and spaces. I offer a greater variety and differentiation of entrances, which simplifies orientation and promotes harmony with the surroundings. In connection with entrances, I place spaces for extensive recycling stations and waste, and I emphasize ample space for safe parking of bicycles, strollers, and wheelchairs. Entrances are designed to be barrier-free to create an inclusive environment for all groups of residents. Common stairwell corridors of the "T06B" system are designed utilitarian and minimal. For greater accessibility, I propose a slight change in the elevator's placement. The rest of the spaces remain dispositionally in their original state, but I suggest examples of possible materials and accessories that can enhance the overall atmosphere and contribute to a pleasant and bright atmosphere.

On the ground floor, where the cellar cubicles and unused spaces of former laundry rooms and drying rooms are, I propose more radical changes. These spaces offer the potential for placing community, commercial, and social functions, the possible listing of which is provided in the diagram on the opposite page. By opening the façade to the exterior and,

in some cases, adding extensions, I aim to create a systematic solution for these functions and their easy utilization. The placement of amenities will depend on the environment or changes in the composition of apartments or residents' requirements. In some cases, I propose only optimized storage spaces and their easier accessibility and integration within the building. In other cases, I provide shared space solely for residents of the building or individual entrances. I emphasize the connection of the ground floor with the surroundings and the creation of more distinctive space differentiation. Newly designed balconies for apartments on the first floor are used as shading elements for ground-floor spaces transitioning to the exterior. Ground-level extensions create exceptionally designed apartment terraces on the first above-ground floor.

Acknowledging that the ground floor of the building communicates the most information to its surroundings, I strive to select materials carefully. To achieve greater integration of the interior with the exterior, I propose extensive glass surfaces in areas of common functions. These are complemented by wooden details, especially at the main entrances. In addition to wood, I use steel elements. This combination enriches the original entirely concrete façade. Moreover, these materials are suitable for prefabricated components, which can be easily dismantled, replaced, or reused.

Public spaces are closely related to the surroundings and the roof. When designing them, it is necessary to consider the harmony of all aspects and their mutual interaction. If it is possible to place a social room on the roof of the building, commercial functions or extensive storage spaces may appear on the ground floor and vice versa.

5.

new functions on the ground floor level

community space

original state

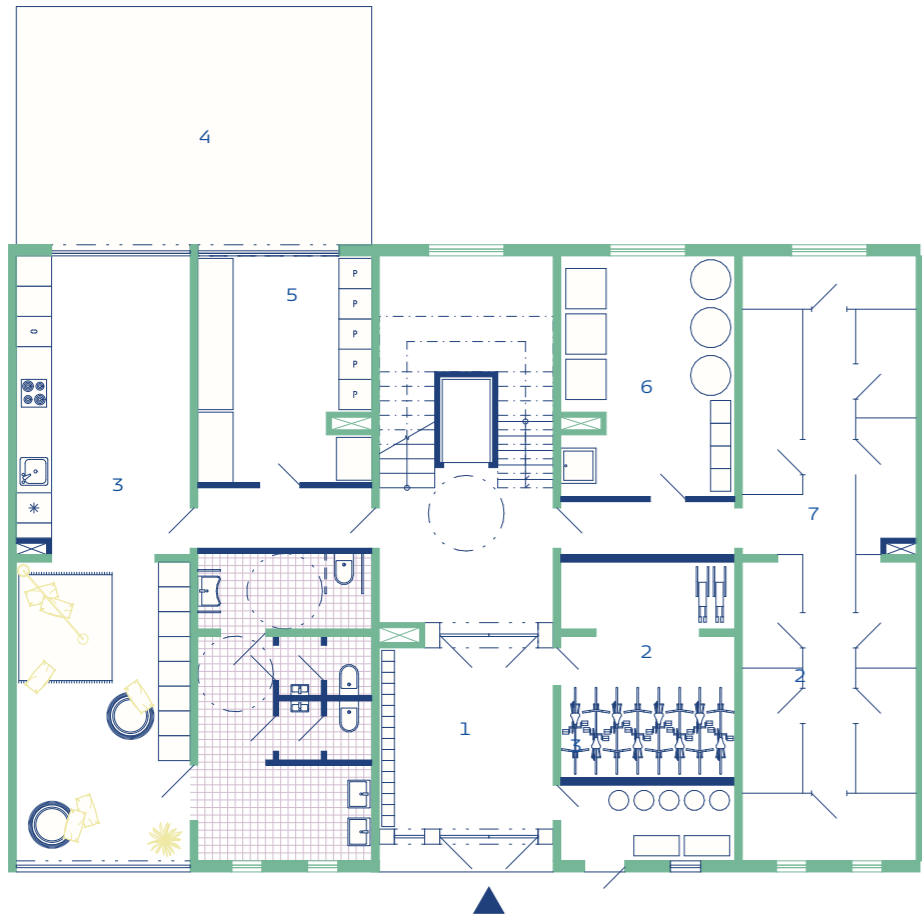
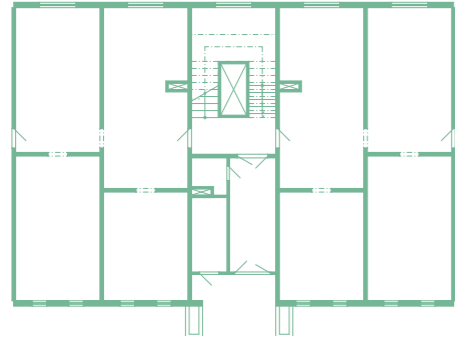

- legend:
- 1 main entrance
 - 2 bicycles, strollers
 - 3 common room
 - 4 outside area
 - 5 common laundry room
 - 6 technical room
 - 7 storage space



new functions on the ground floor level

gym

original state

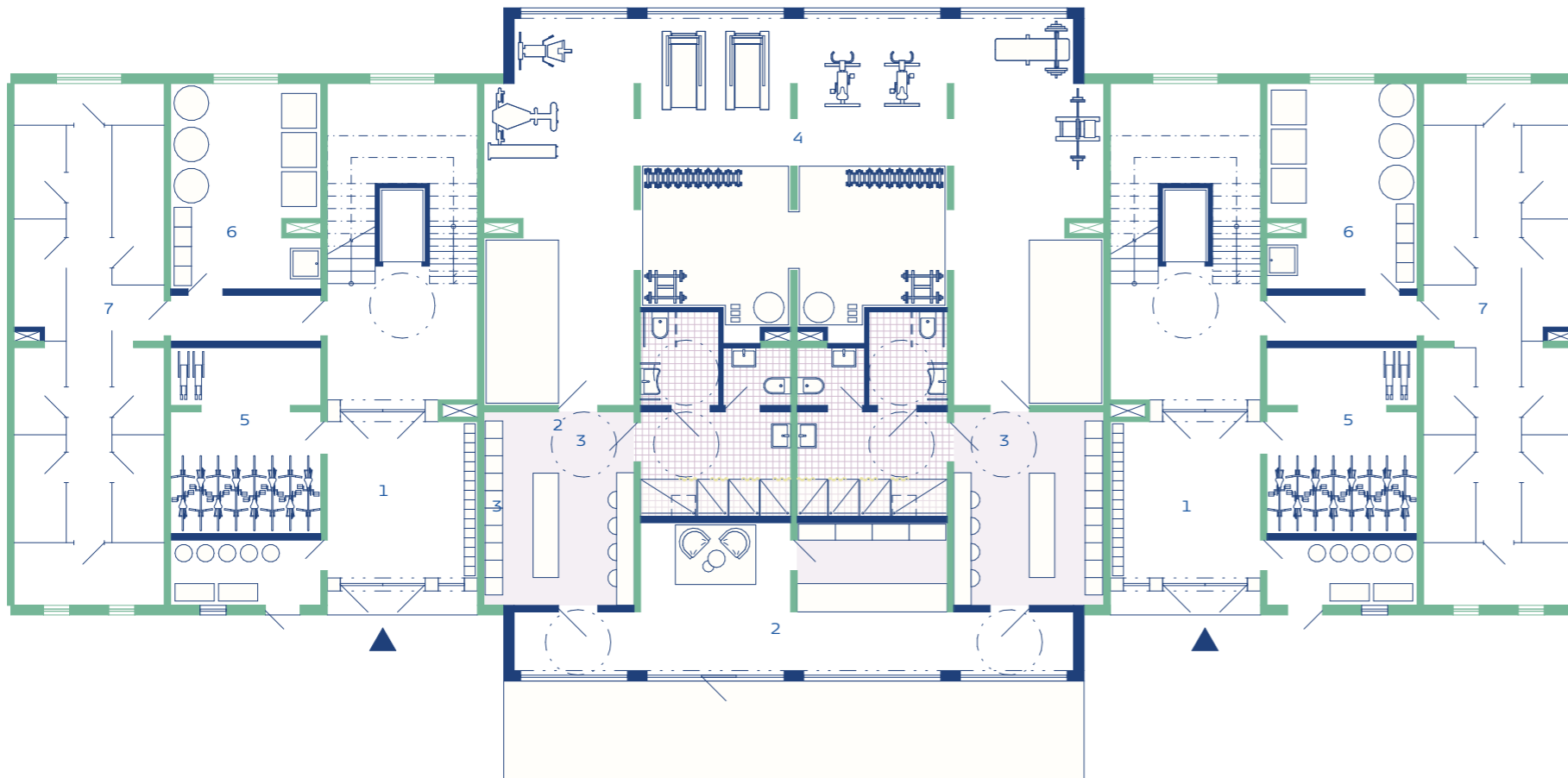
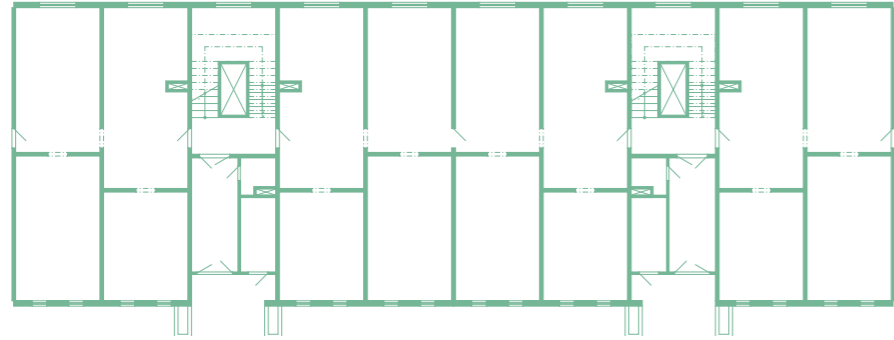

legend:

- 1 main entrance
- 2 gym entrance
- 3 dressing room
- 4 gym area
- 5 bicycles, strollers
- 6 technical room
- 7 storage space



new functions on the ground floor level

cafe

original state

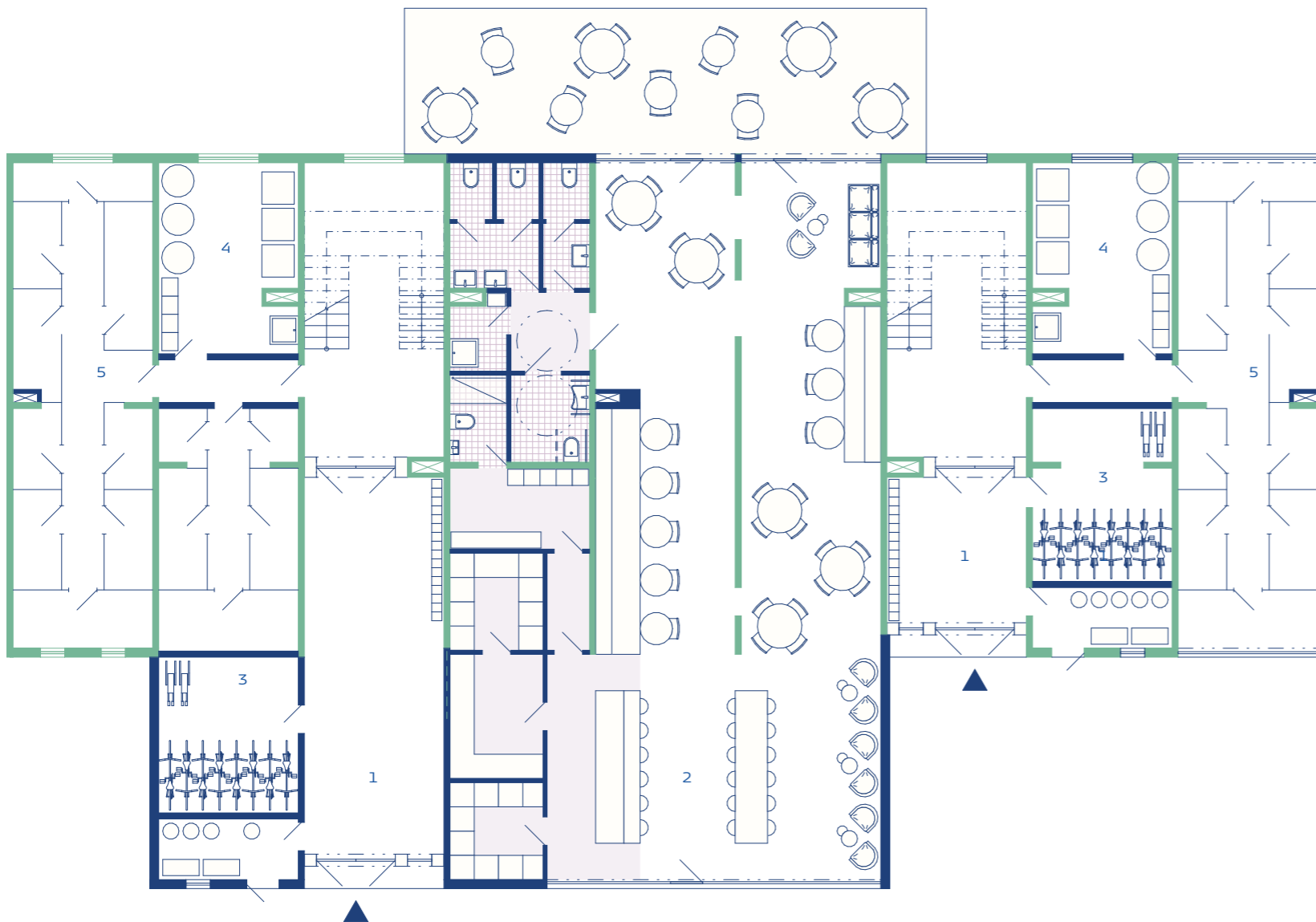
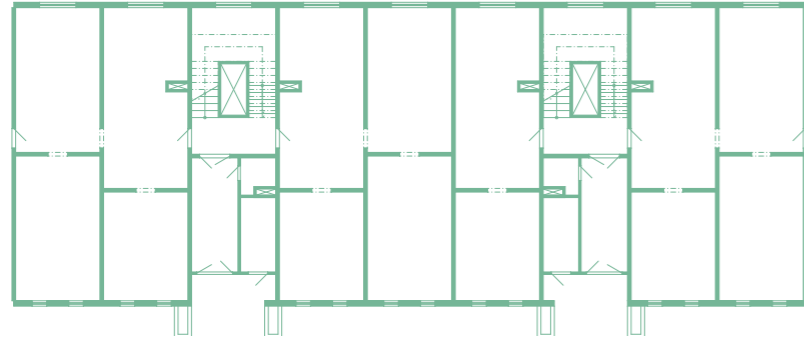

- legend:
- 1 main entrance
 - 2 cafe
 - 3 bicycles, strollers
 - 4 technical room
 - 5 storage space



5.

Proposals
layout

alternative floor plan layouts

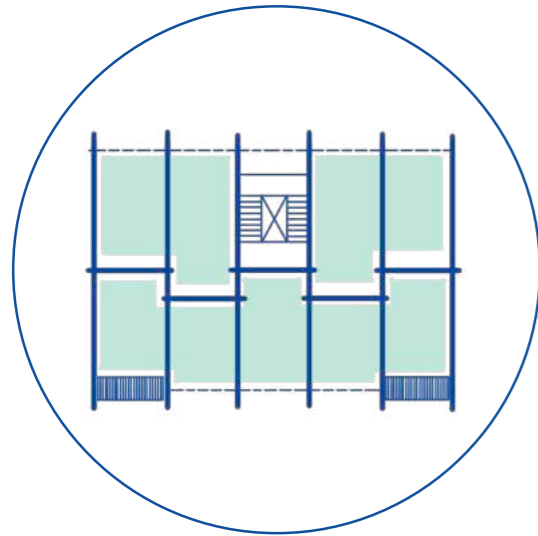

co housing concept

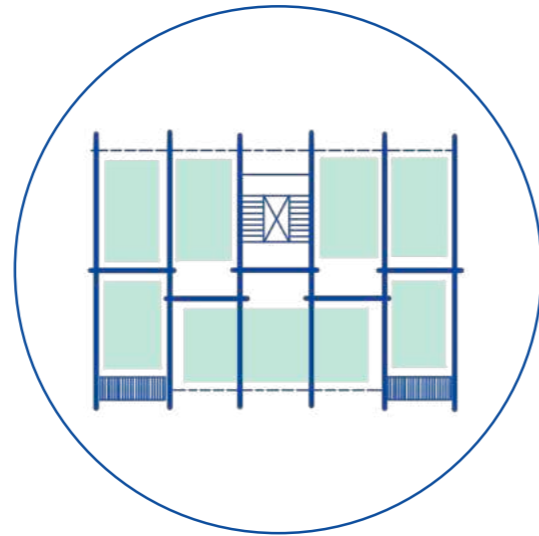

new public function

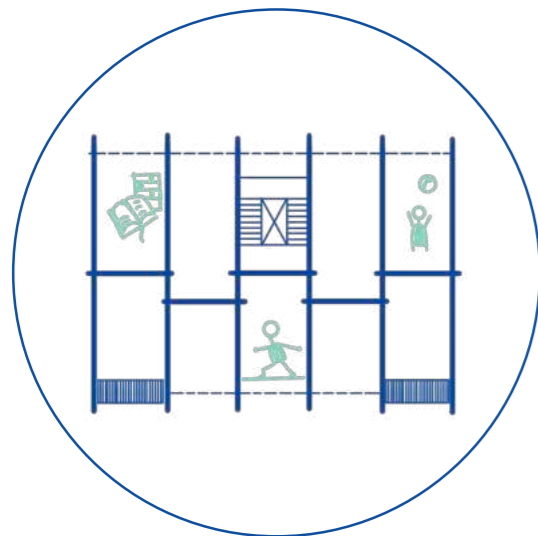

barrier-free solution

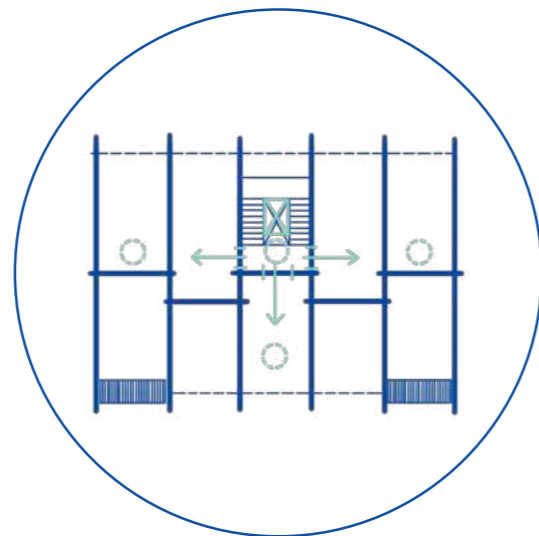

ending sections variations

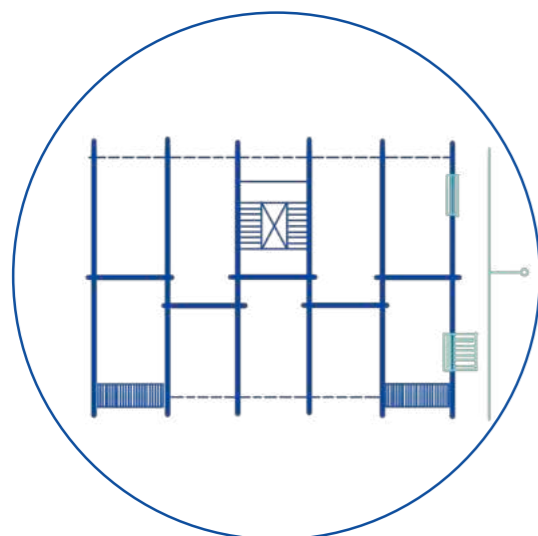

new overhanging structures

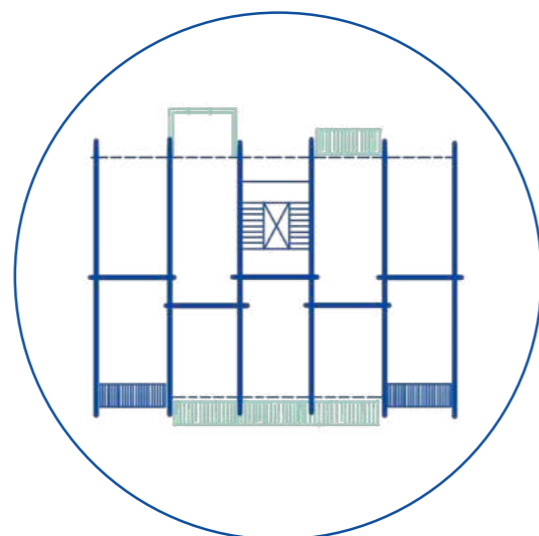

Czech apartment standards explanation

- The Czech system of apartment standards (categories) uses numbers and recognises whether or not a kitchen is a part of one of the rooms assigned for living. In this case, a room assigned for living means bedroom/living room/office/dining room etc. (on the other hand, bathroom / technical room / laundry room are not rooms assigned for living) With this in mind, we can categorise apartments as 1+1, 2+1 - meaning the apartment has one (or two...) rooms assigned for living plus a separate room for kitchen. If we use categories such as 1K, 2K, and 3K we talk about apartments that include one (or two or three...) rooms designed for living "K" means a kitchen is a part of one of these rooms. The most common example of this scenario is an apartment with one big living space equipped with a kitchen, dining area as well as living room area.

It isn't possible to limit the layout topic solely to the layouts of individual apartment units in the case of residential buildings, but they are its main components. I extensively address the layouts of shared spaces, extensions, and newly designed rooftop structures in previous chapters, and in this one, I focus primarily on the floors with apartments.

The conception of panel houses was primarily minimal living spaces at the time. Their equipment was planned to be austere and systematic, composed of the smallest possible number of easily prefabricated elements. Even though the area of individual apartments usually corresponds to their standard, apartments are often designed to be small and functional. They do not provide variable opportunities and can meet the expectations of a small range of residents. Although I don't believe that living in a panel building should be designed for all the layers of the population, a much wider range of choices should be available.

I deal with the design of alternative layouts that can be created within individual residential floors extensively and in-depth. I created six basic situations of possible changes. And I try to propose at least one for each section A, B, and C. These sections are the basic building blocks of the "T06B" system, and most residential buildings of this system throughout the Czech Republic are built based on them.

With these six groups, I respond to stimuli arising from the analysis of the entire system. I make changes that can be used for individual apartments, entire floors, a single lane in a residential building, or systematically applied to an entire residential building. They are also divided into degrees and intensities of interventions, from undemanding changes that involve merely the

need to break through a larger passage in a load-bearing wall to the most extensive release of the floor plan and the addition of extensive suspended structures.





Regarding the offering of more diverse standards for individual apartments, I proceed in the same way. I create standard apartment units from the smallest studio apartments to housing for larger families, which are designed ergonomically with an emphasis on solving the problems of existing minimal bathrooms, kitchens, and lack of storage space. For more radical changes, I consider merging individual smaller apartment units to create large intergenerational apartments. In these cases, I add spaces for new installation cores, which help the layouts gain the desired connection between individual rooms and better respond to current requirements.

I strive for inclusivity by expanding the possibilities of standard residential buildings by placing student and shared housing and creating layout variants of barrier-free apartment units in various standards. Alternatively, I intersperse the function of housing with a public function located on floors where residential units are typically located.

Student and shared housing are always conceived as an apartment occupying the entire floor. I design individual rooms to have a private bathroom and be suitable for individuals or couples. Common areas provide a kitchen, dining area, and living room, always with an emphasis on access to outdoor space.

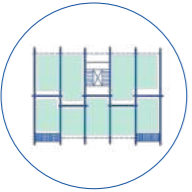
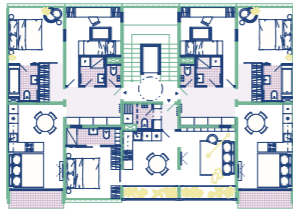
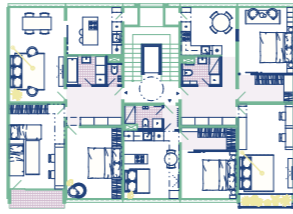
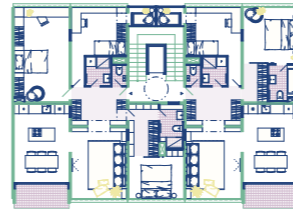
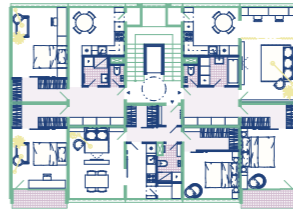
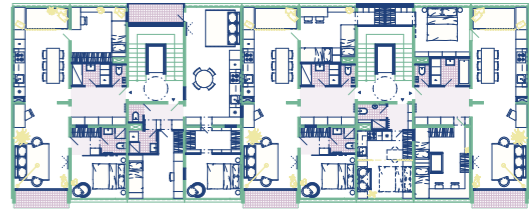
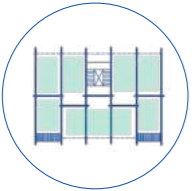
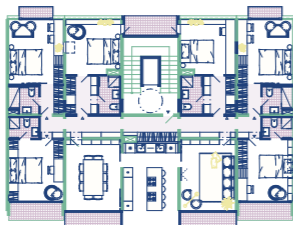
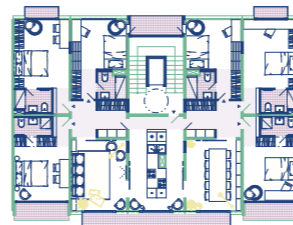
Public amenities are also designed for the entire floor area. Thinking about the resident's comfort, a function is placed here that will not disturb neighbouring apartment units, will be used primarily during the day, and its operation will not compromise the safety of the entire building. Such functions may include a children's group or a yoga studio.

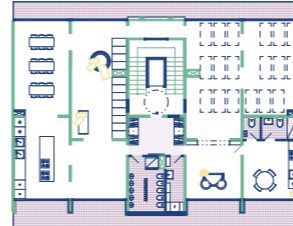
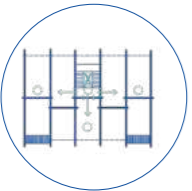
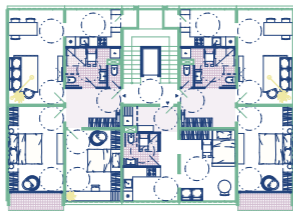
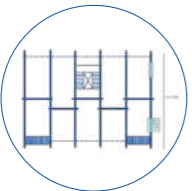
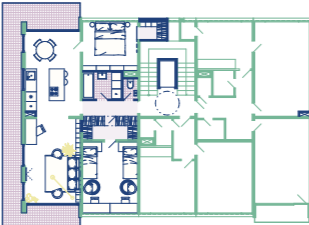
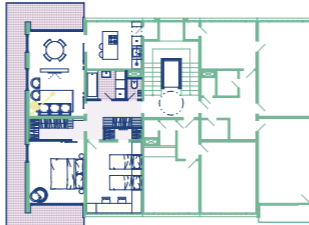
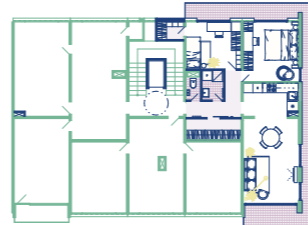
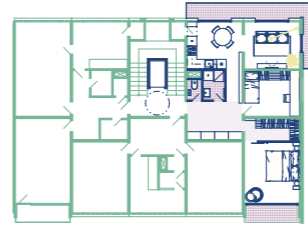
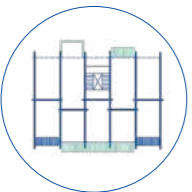
I keep in mind that the equipment and appearance of housing are highly dependent on personal preferences. My goal is to verify and demonstrate various possibilities. Their combination and the final form of each interior can vary significantly in each project. However, the basic concept of each variant is carefully crafted with a close connection to the system of the entire building to make it universal.

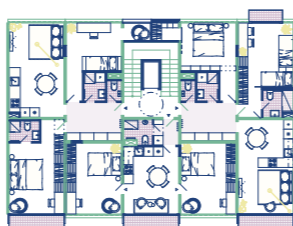
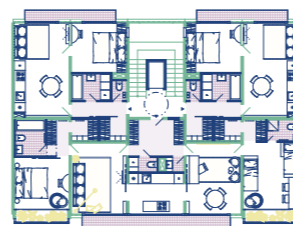
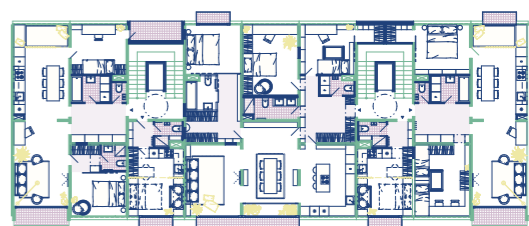
	A section		B section		C section
1 alternative floor plan layouts 	A1/a 	A1/b 	B1/a 	B1/b 	C1/a 
2 co housing concept 	A2/a 		B2/a 		
3 new public function 			B3/a 		
3 barrier-free solution 	A4/a 				
4 ending section variations 	A5/a 	A5/b 	B5/a 	B5/b 	
5 new overhanging structures 	A6/a 	A6/a 	B6/a 		C6/a 

alternative floor plan layouts

A1/a

original state

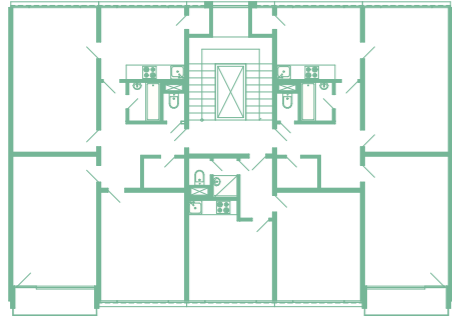

proposed units

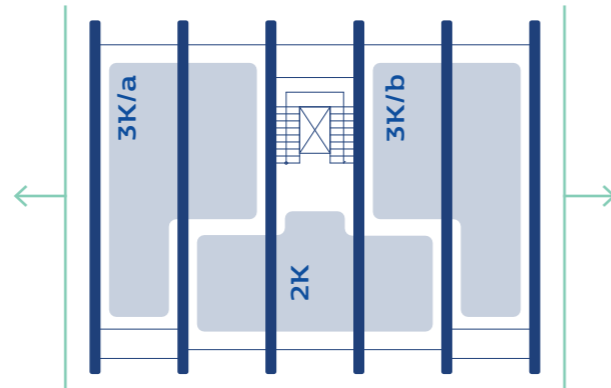

balance

3K/a	65m ² +loggia
3K/b	65m ² +loggia
2K	46m ² +winter garden

font facade

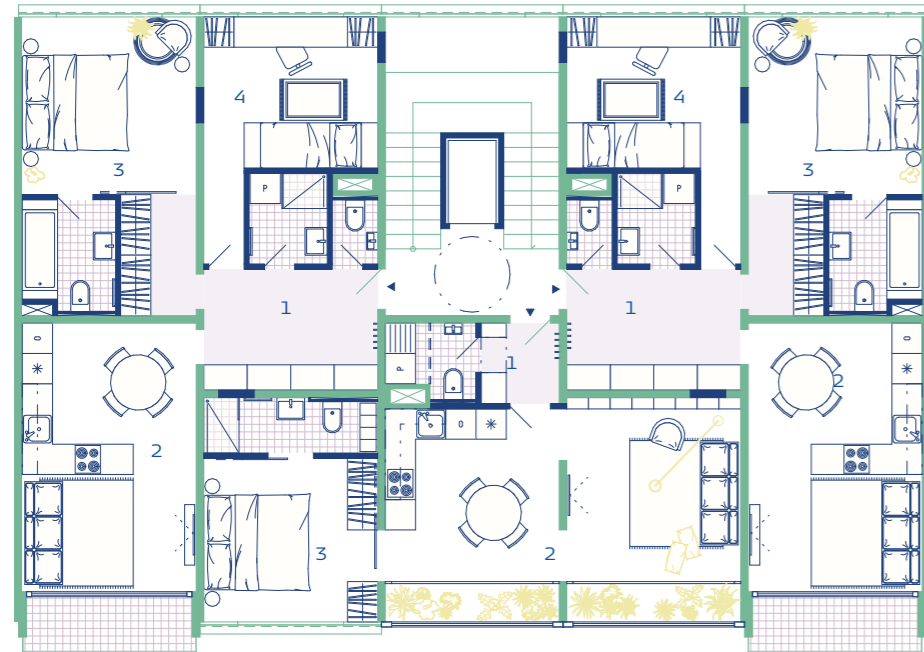
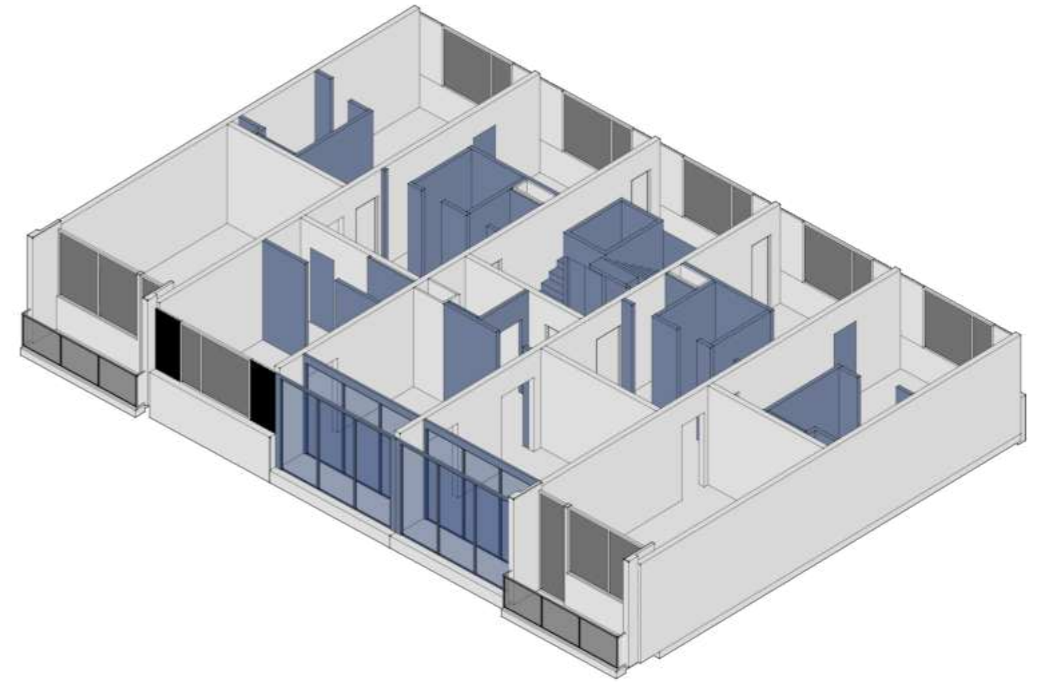

legend:

1	entrance hall
2	living space
3	master bedroom
4	bedroom



back facade

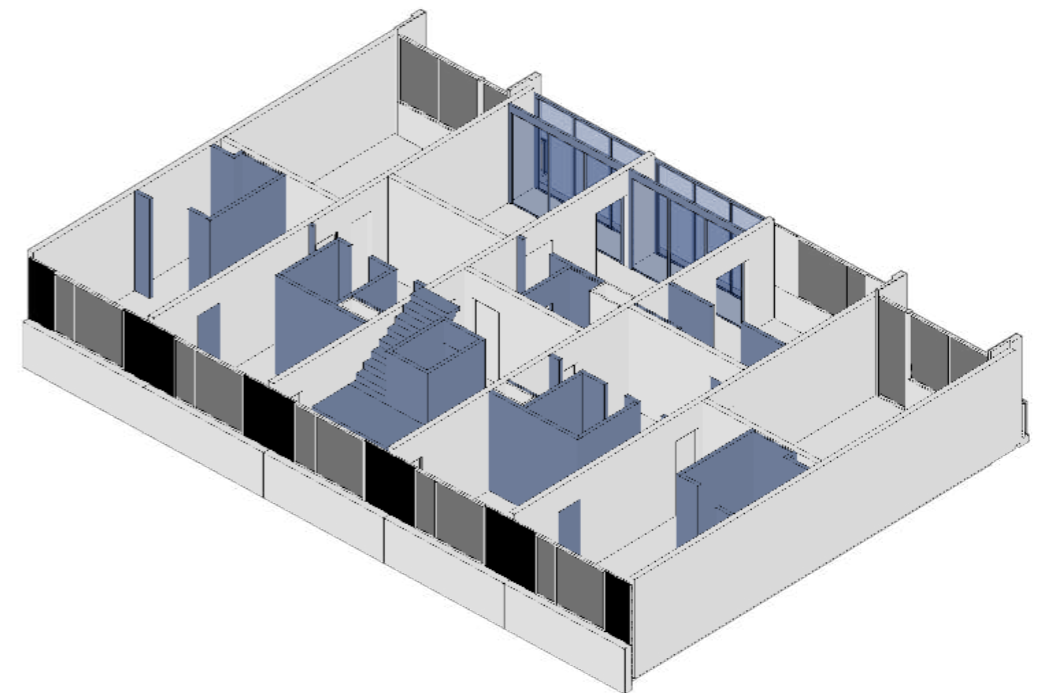

alternative floor plan layouts

A1/b

original state

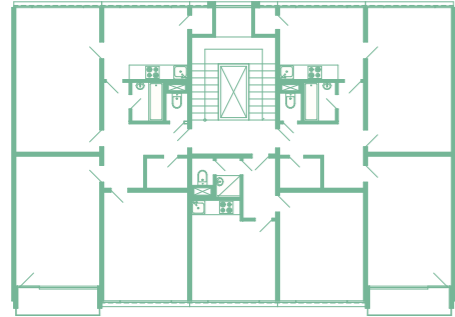

proposed units

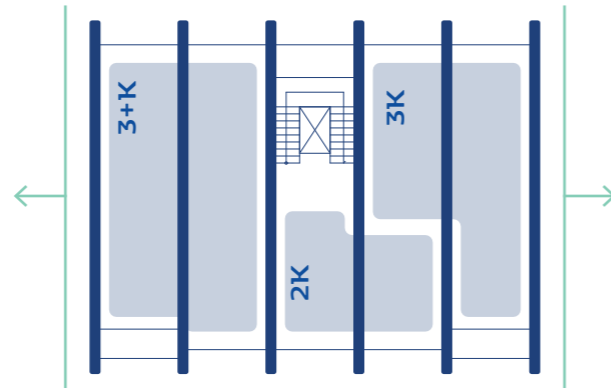

balance

3+K	83m ² +loggia
3K	65m ² +winter garden
2K	37m ²

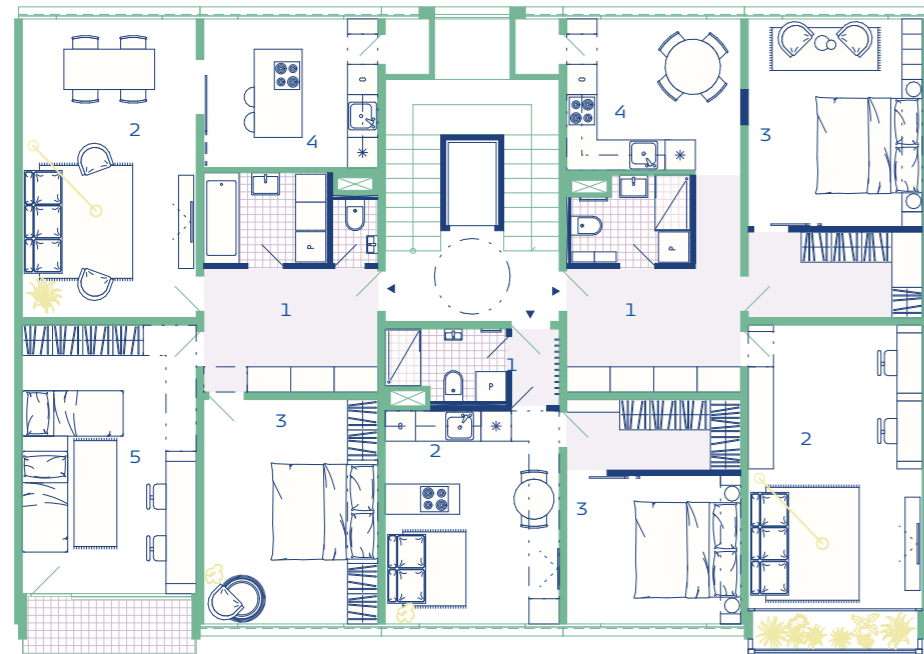

legend:

1	entrance hall
2	living space
3	master bedroom
4	kitchen
5	bedroom

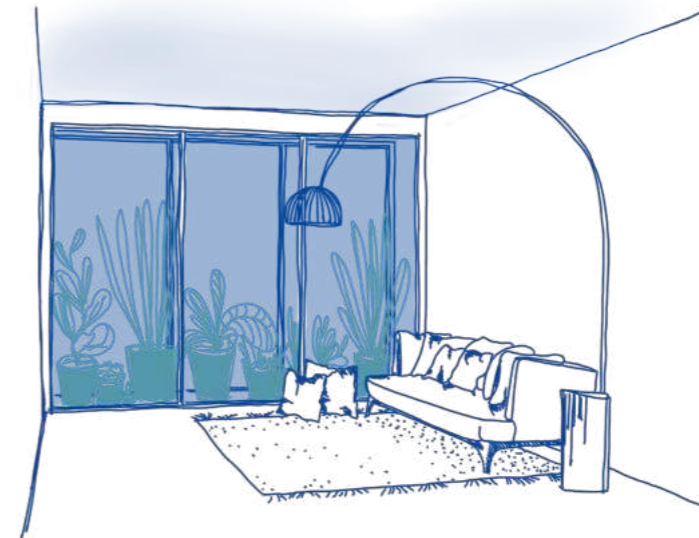

alternative floor plan layouts

B1/a

original state

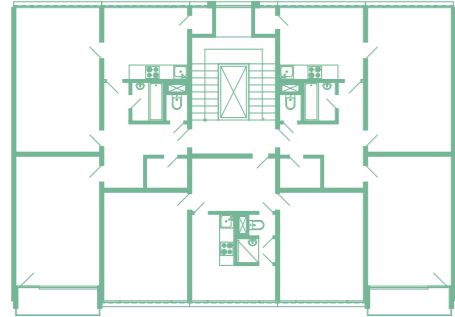

proposed units

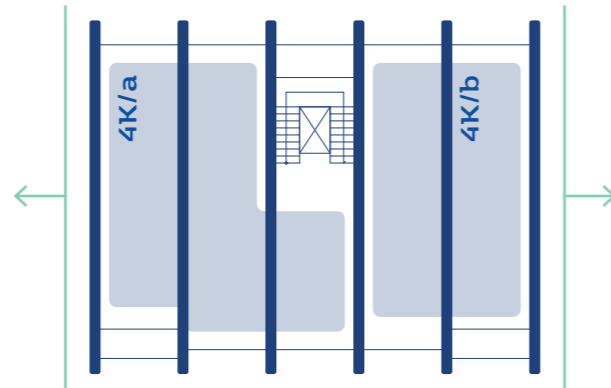

balance

4K/a	103m ²
	+loggia
4K/b	83m ²
	+loggia

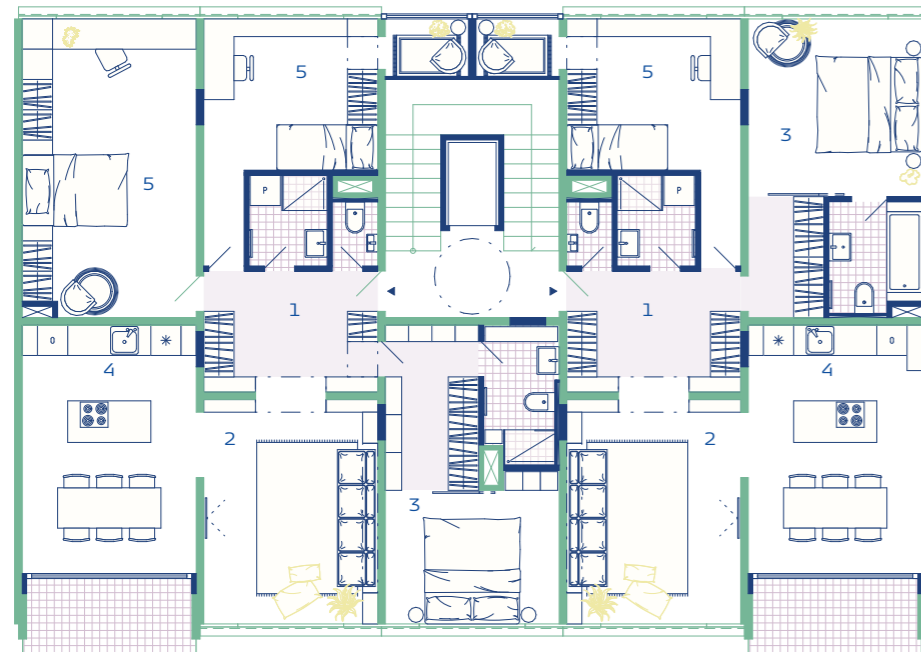

legend:

- 1 entrance hall
- 2 living space
- 3 master bedroom
- 4 kitchen
- 5 bedroom



alternative floor plan layouts

B1/b

original state

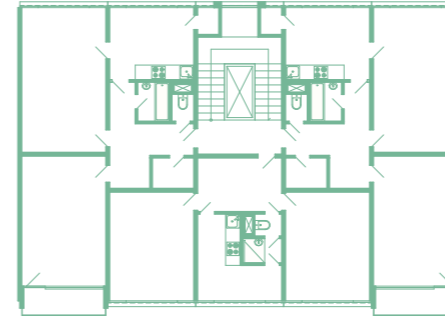

proposed units

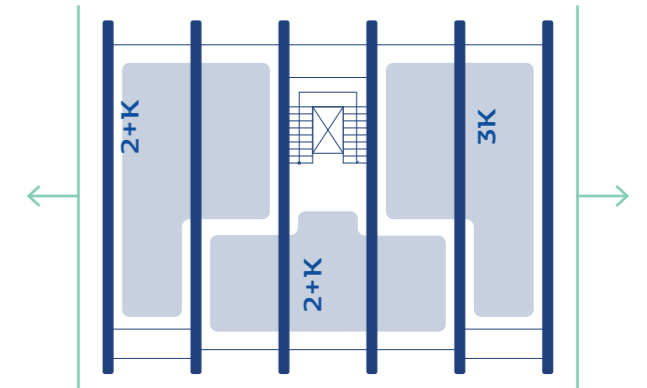

balance

2+K	65m ²
	(shared apartment)
	+loggia
3K	65m ²
	+loggia
2+K	37m ²

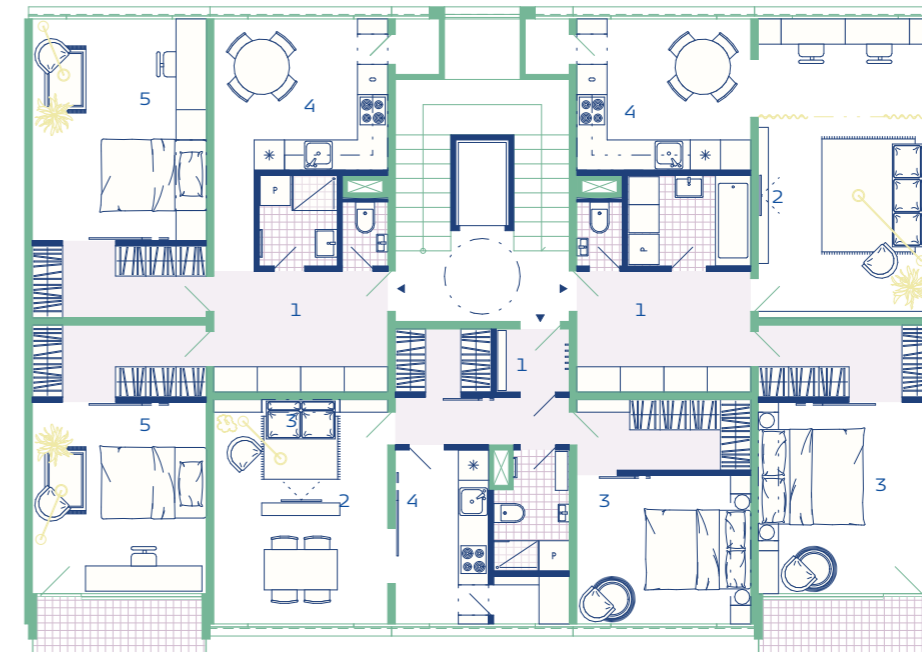

legend:

- 1 entrance hall
- 2 living space
- 3 master bedroom
- 4 kitchen
- 5 bedroom



alternative floor plan layouts

C1/a

original state

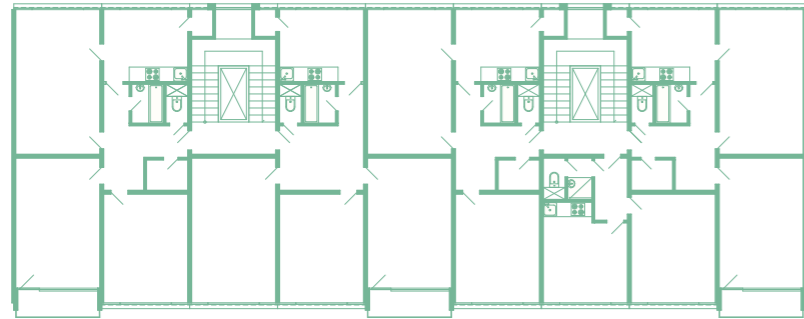

proposed units

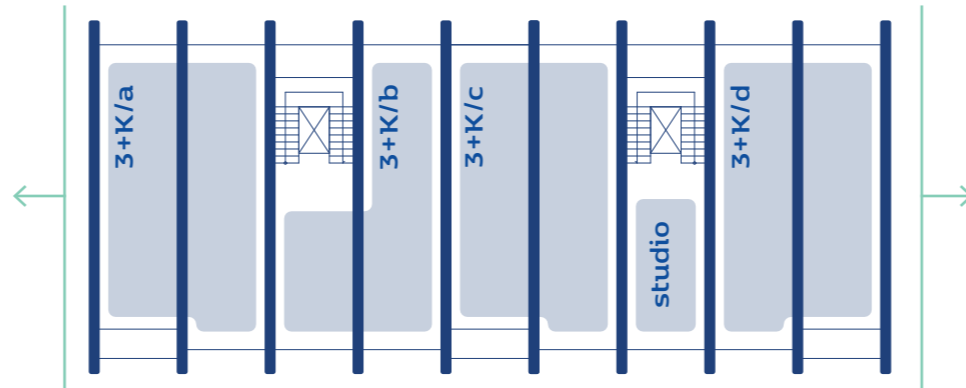

balance

4+K/a	83m ²
	+loggia
4+K/b	83m ²
	+loggia
4+K/c	83m ²
	+loggia
4+K/d	83m ²
	+loggia
studio	22m ²

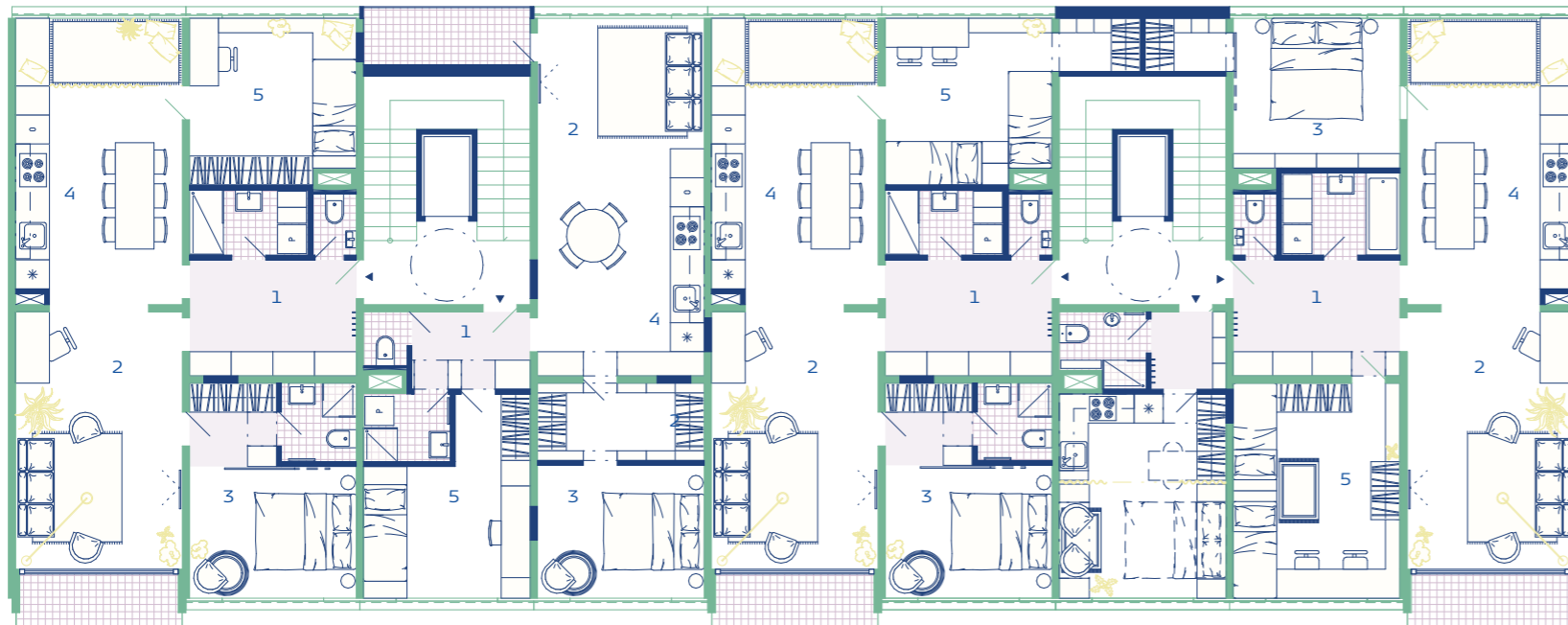

legend:

- 1 entrance hall
- 2 living space
- 3 master bedroom
- 4 kitchen
- 5 bedroom



co-housing concept

A2/a

original state

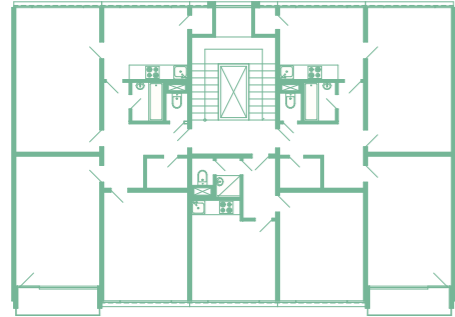

proposed units

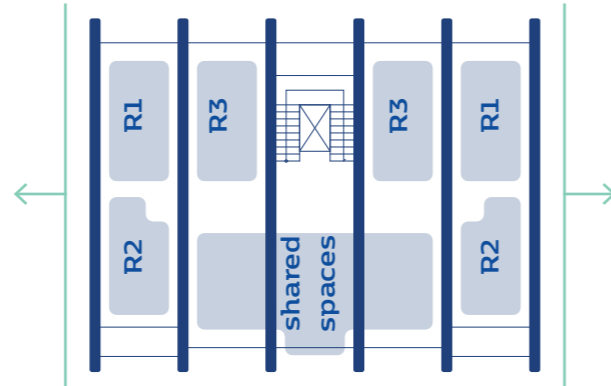

balance

R1	21m ² +loggia
R2	17m ² +loggia
R3	21m ² +shared loggia
shared space	50m ² +shared loggia

font facade

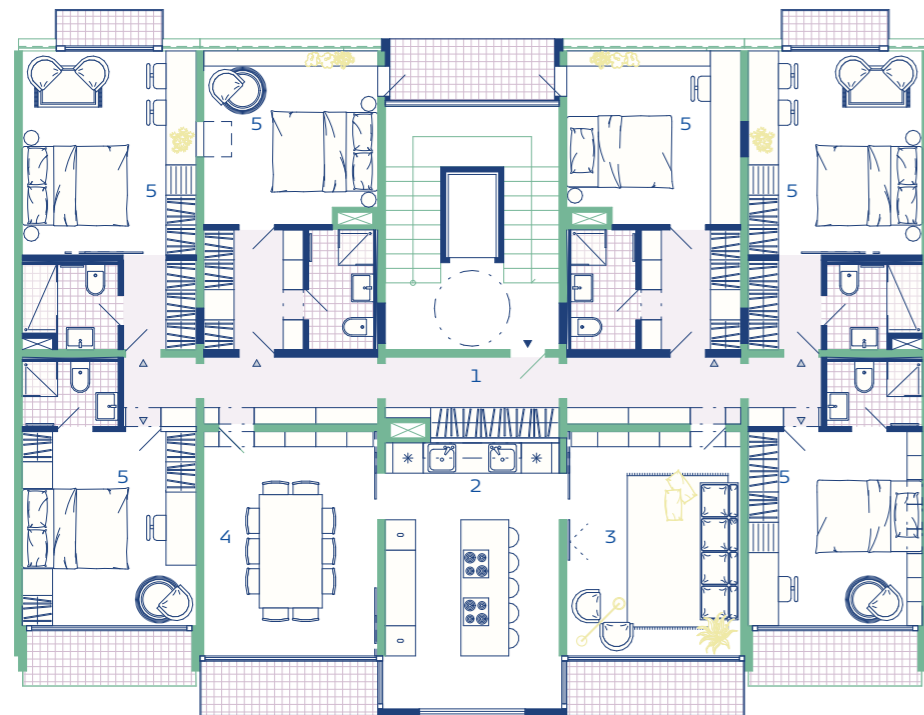
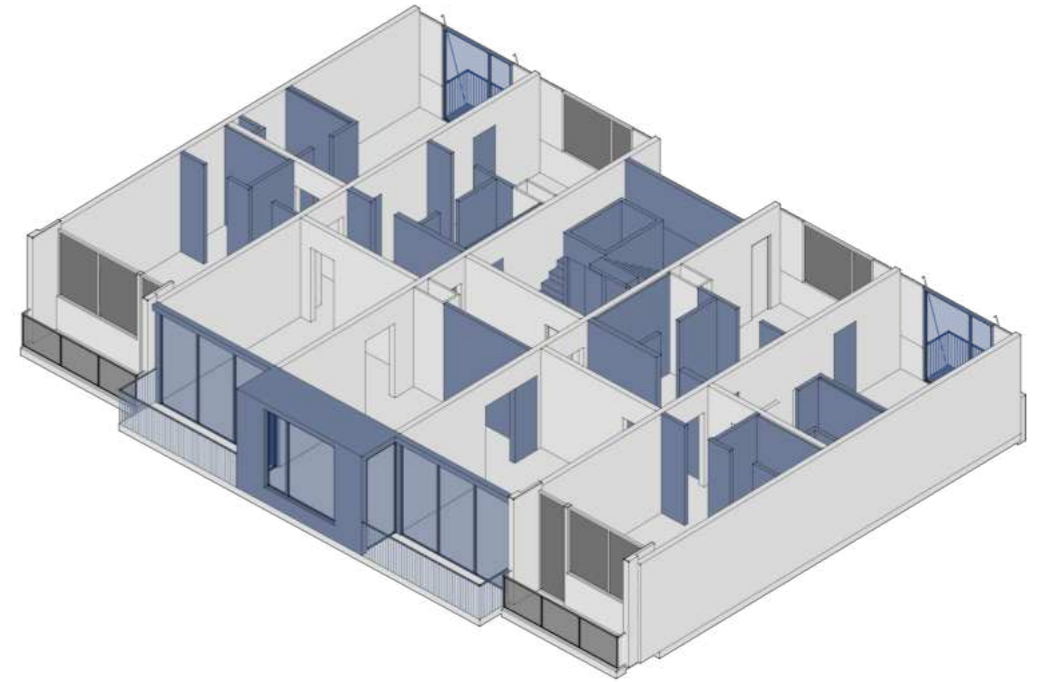

legend:

- 1 entrance hall
- 2 shared kitchen
- 3 living room
- 4 dining room
- 5 private room



back facade

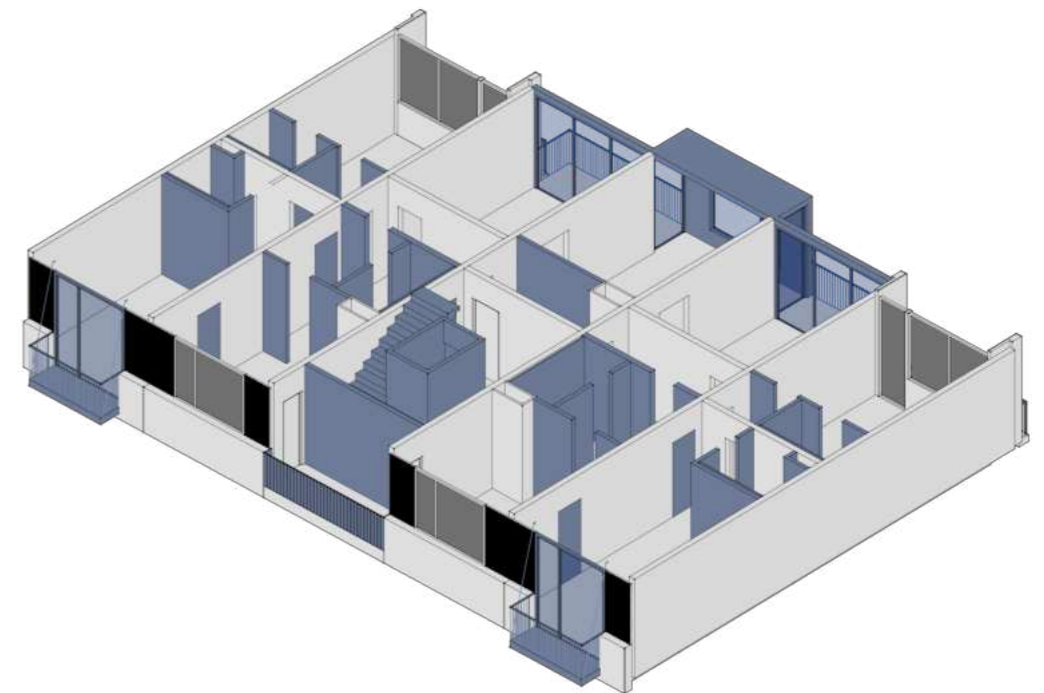

co-housing concept

B2/a

original state

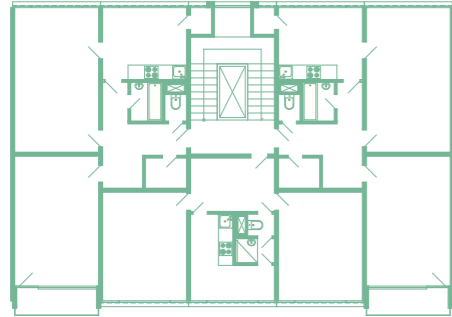

proposed units

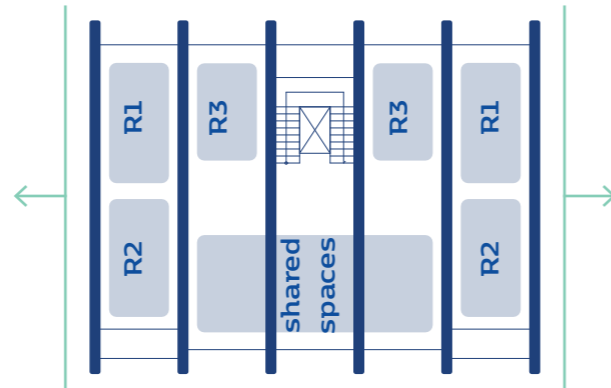

balance

R1	21m ² +loggia
R2	17m ² +loggia
R3	17m ² +shared loggia
shared space	50m ² +shared loggia

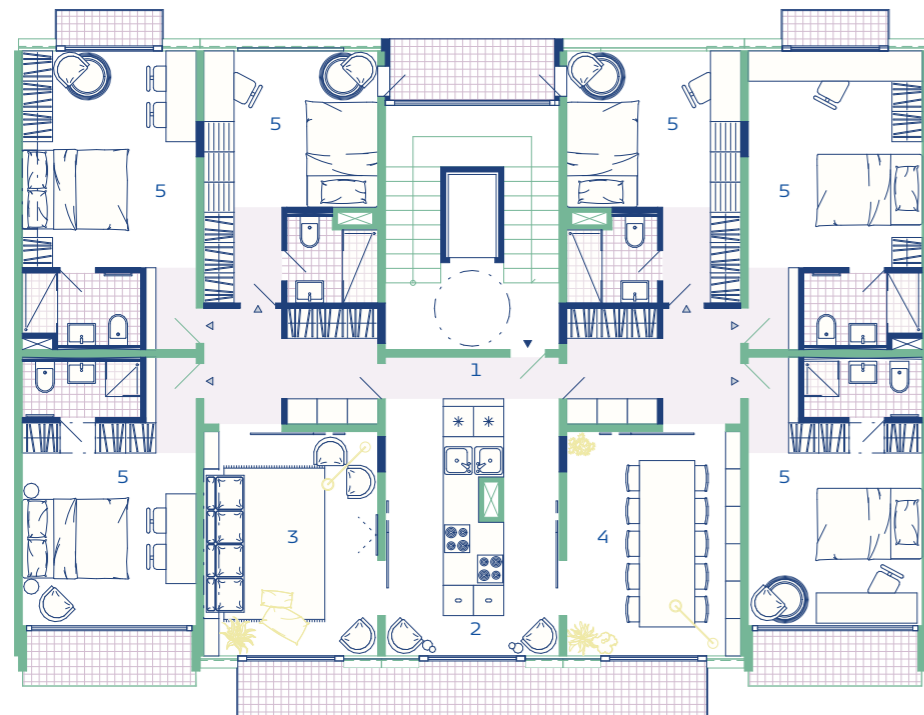

legend:

- 1 entrance hall
- 2 shared kitchen
- 3 living room
- 4 dining room
- 5 private room

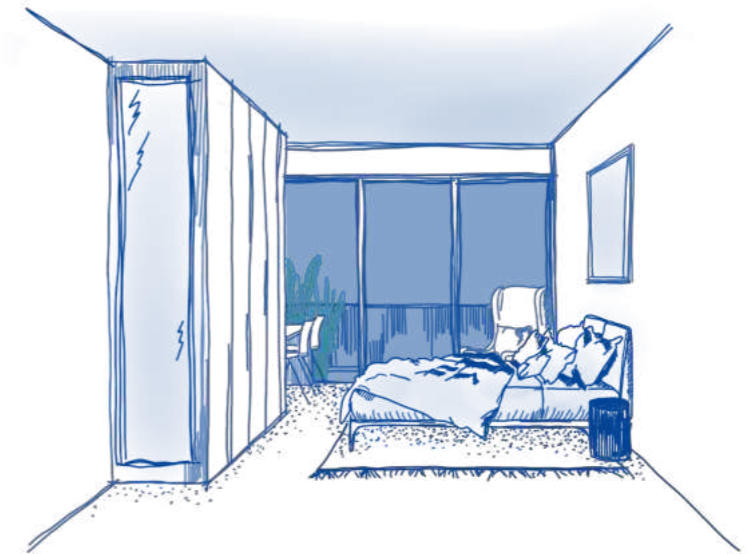

new public function

B3/a (children's group)

original state

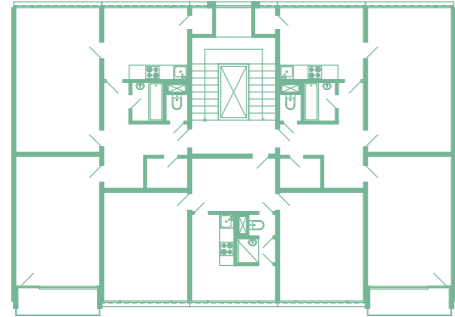

proposed units

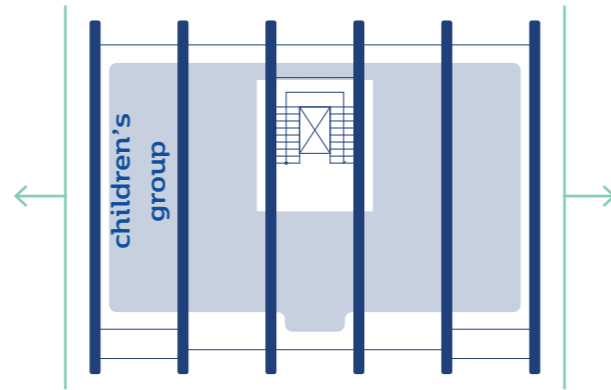

balance
 children's group 187m²
 +2 balconies

font facade

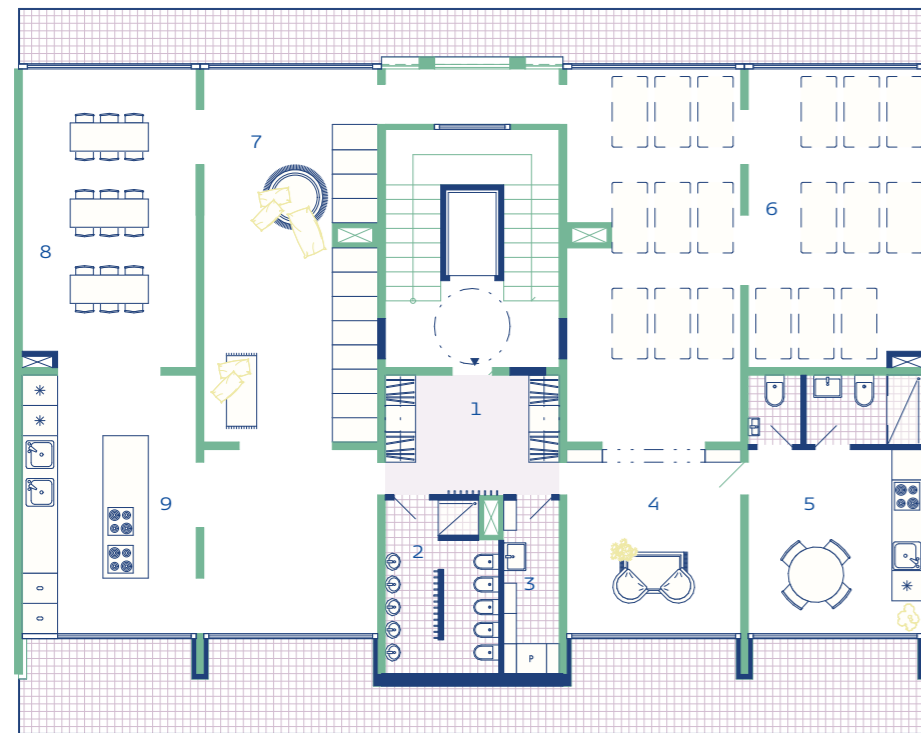
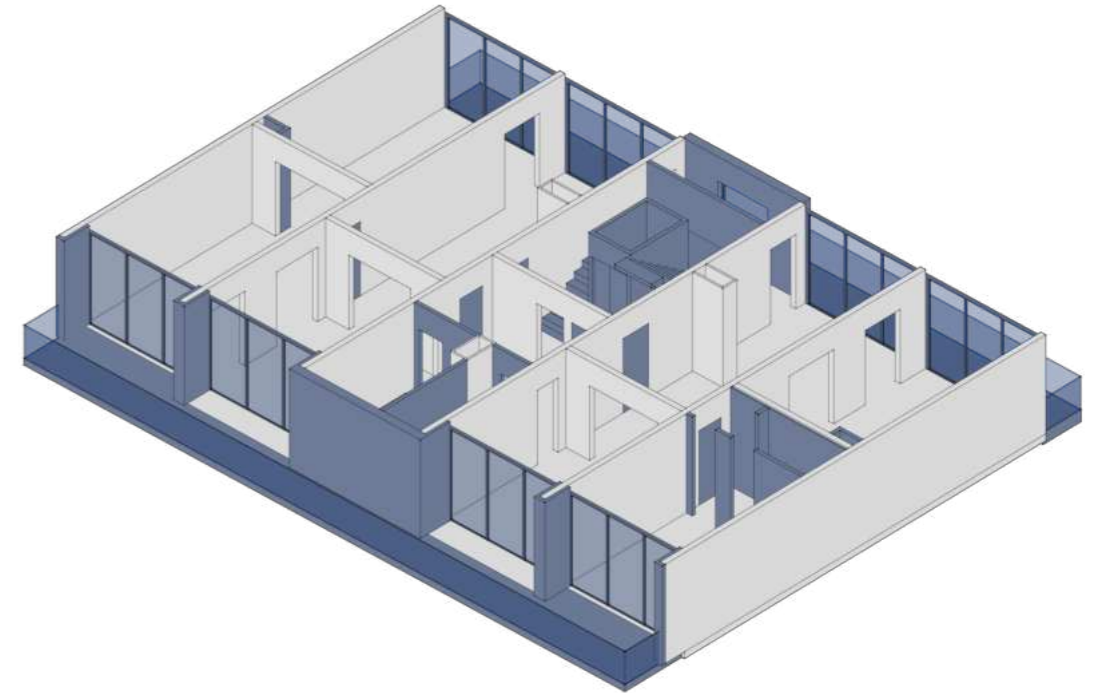

- legend:
- 1 entrance
 - 2 bathroom
 - 3 technical room
 - 4 waiting room
 - 5 professors room
 - 6 sleeping/play room
 - 7 play room
 - 8 dining room
 - 9 kitchen

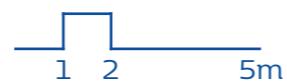

back facade

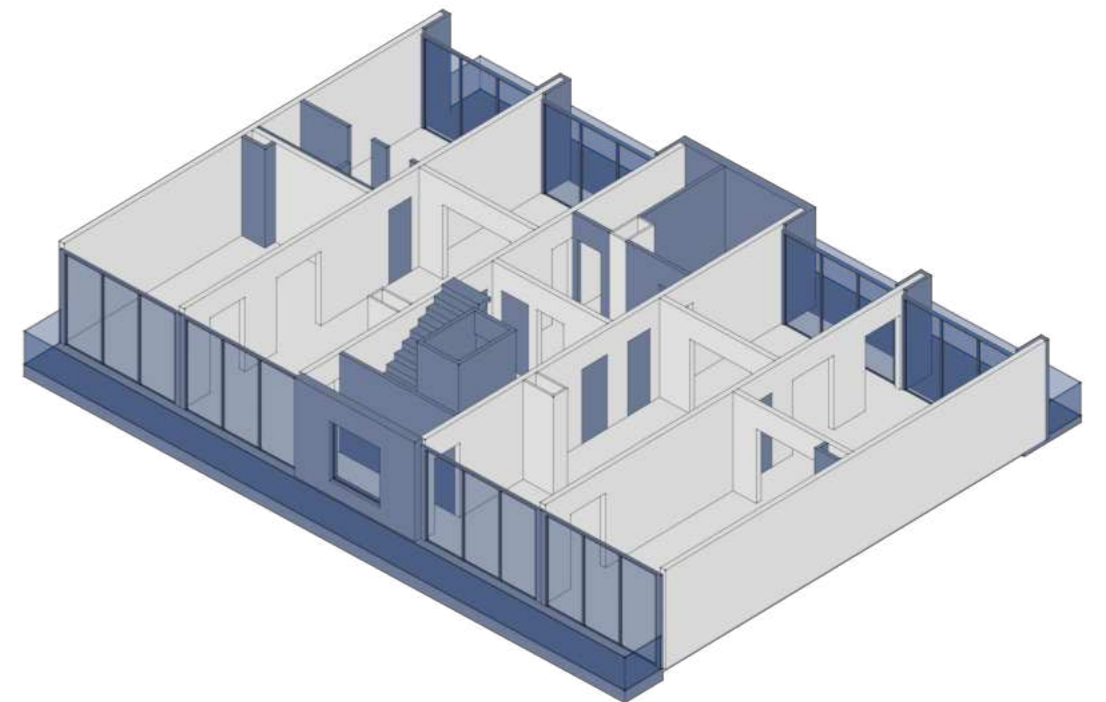

barrier-free solution

A4/a

original state

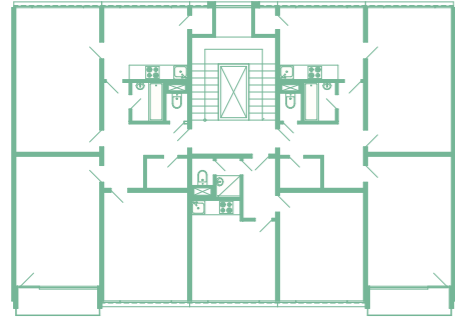

proposed units

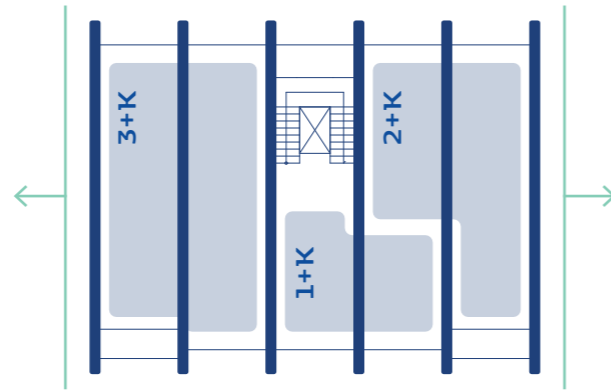

balance

3+K	83m ²
	+loggia
2+K	65m ²
	+loggia
1+K	37m ²

font facade

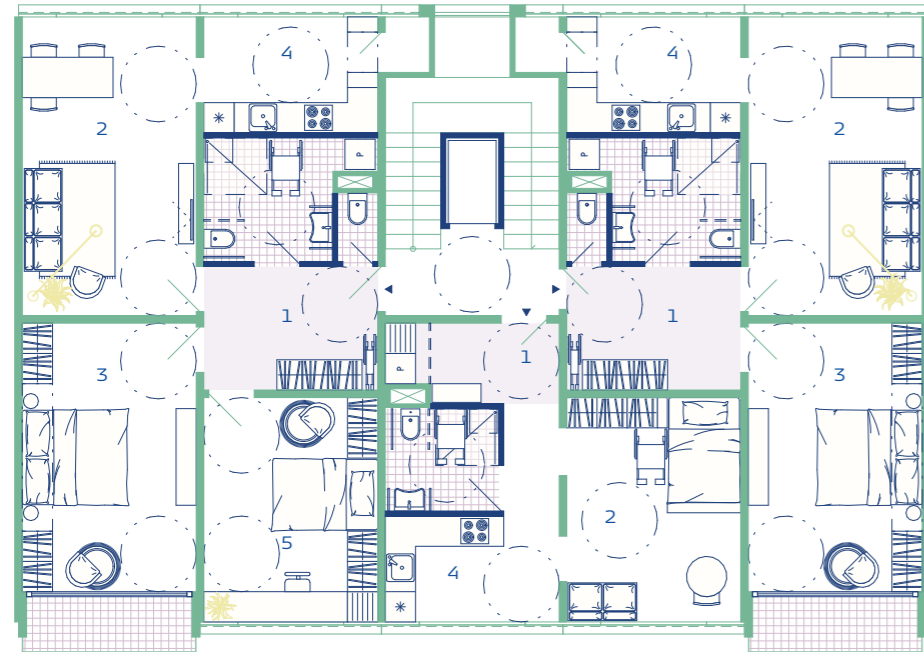
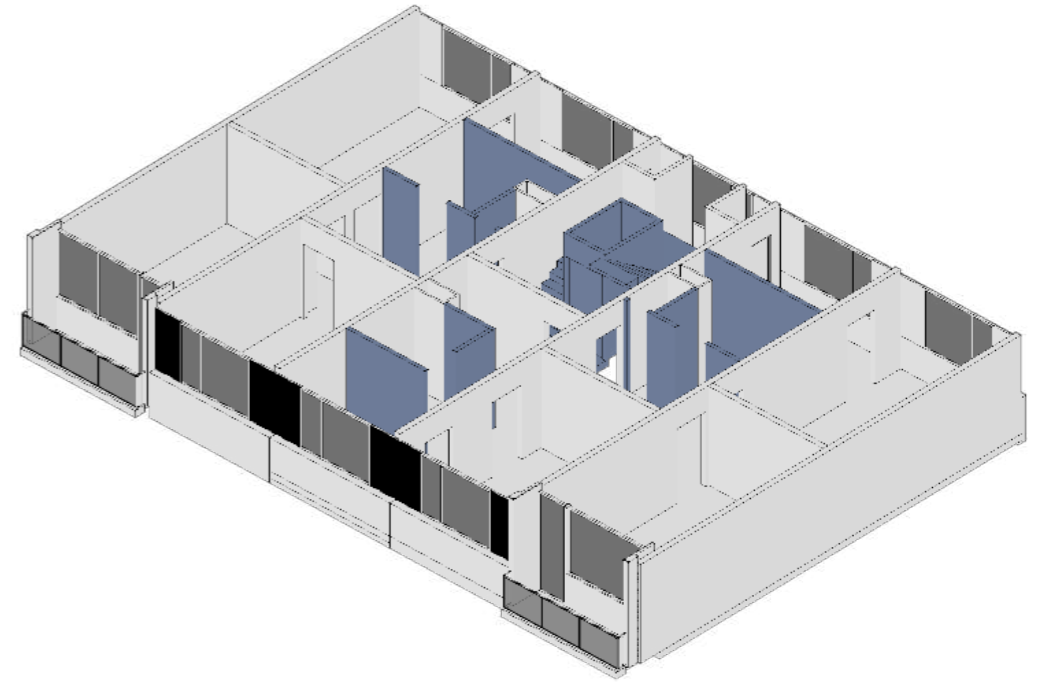

legend:

- 1 entrance hall
- 2 living space
- 3 master bedroom
- 4 kitchen
- 5 bedroom



back facade

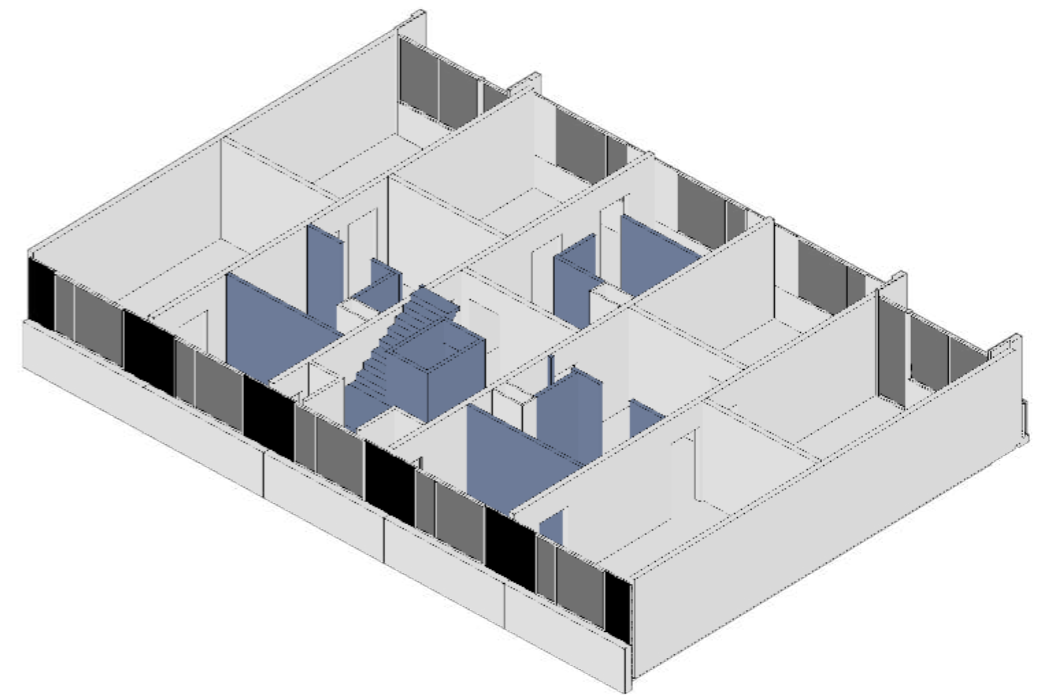

ending section variations

A5/b

original state

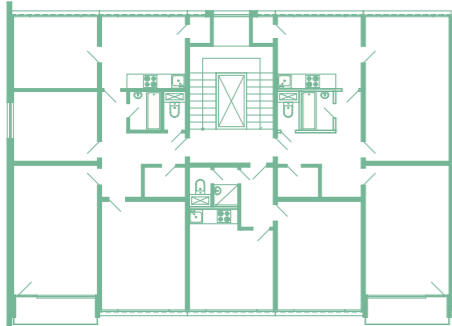

proposed units

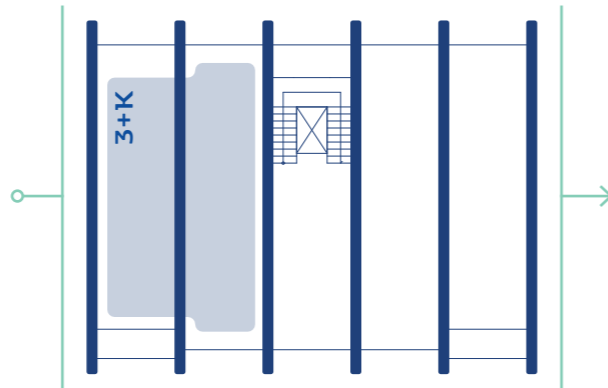

balance
 3+K 83m²
 +balcony

font facade

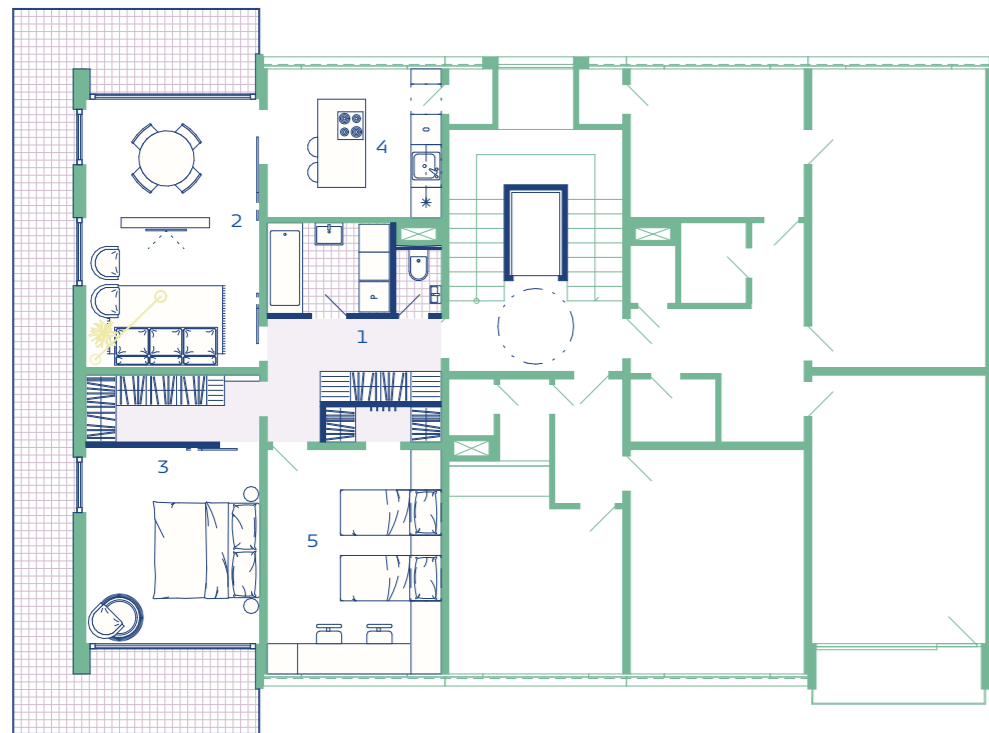
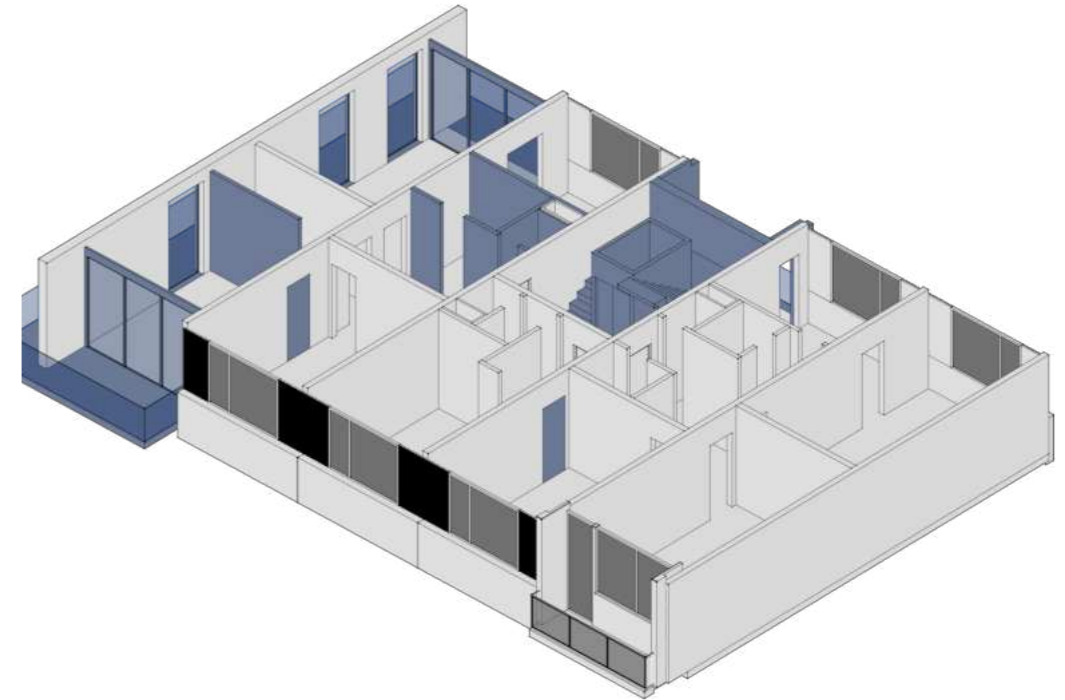

legend:
 1 entrance hall
 2 living space
 3 master bedroom
 4 kitchen
 5 bedroom



back facade

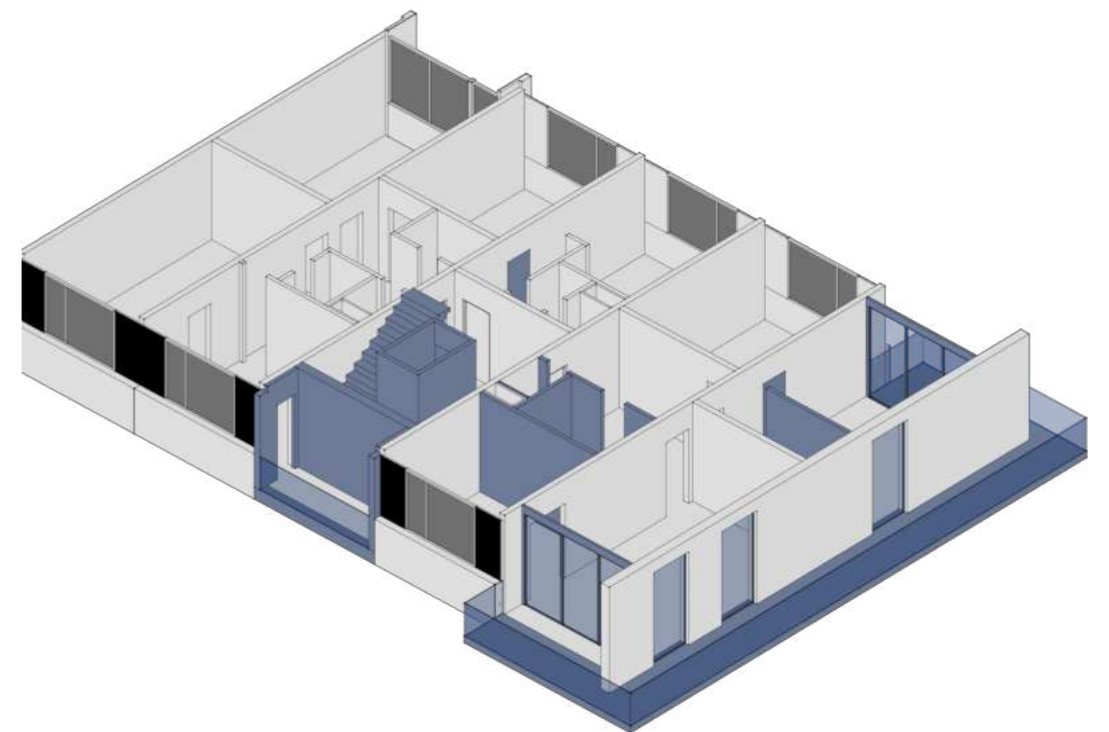

ending section variations

A5/a

original state

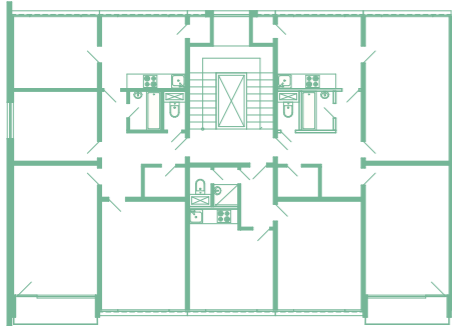

proposed units

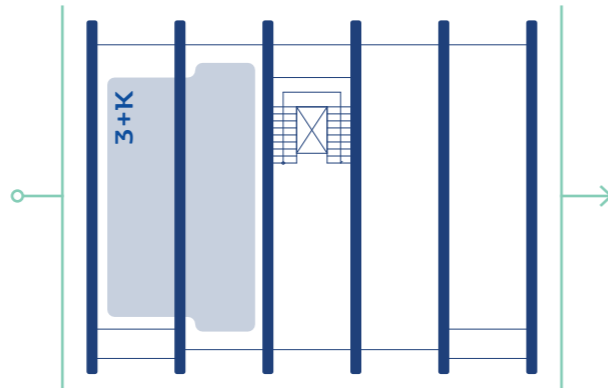

balance
3+K 83m²
+balcony

ending section variations

B5/a

original state

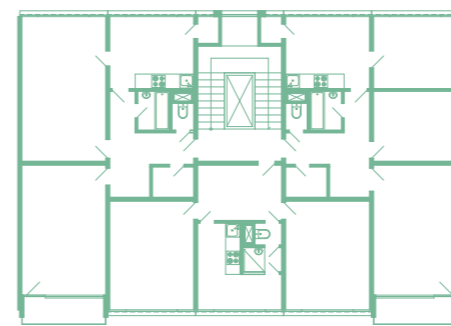

proposed units

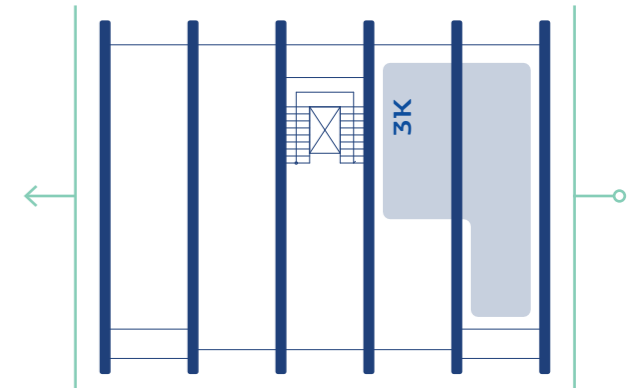

balance
3K 68m²
+balcony

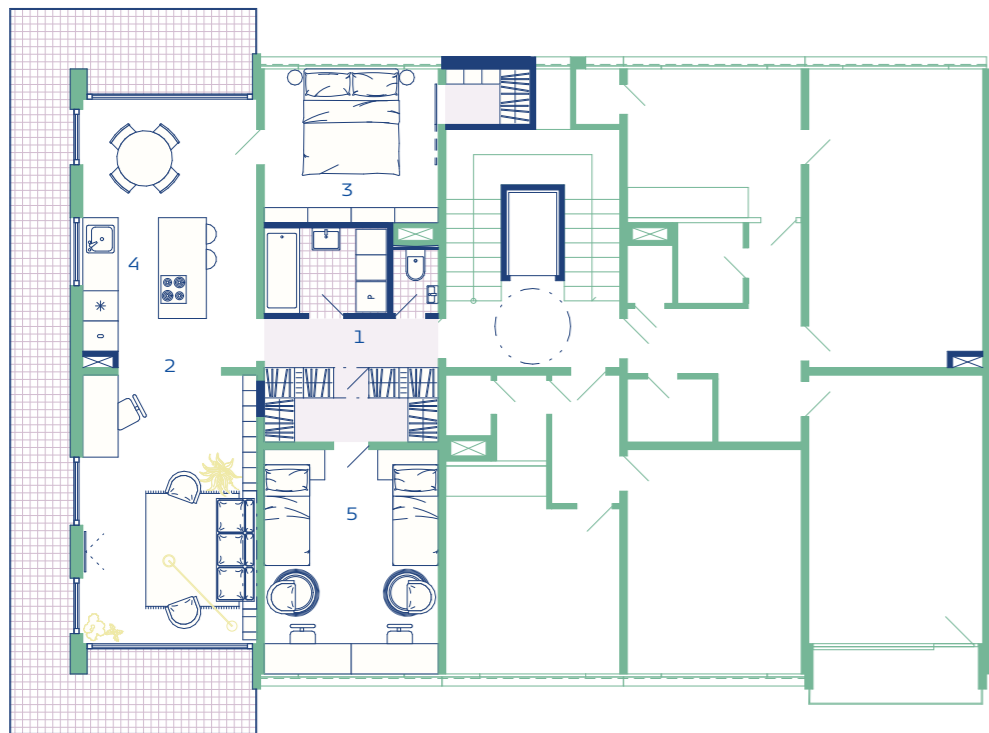

legend:
1 entrance hall
2 living space
3 master bedroom
4 kitchen
5 bedroom

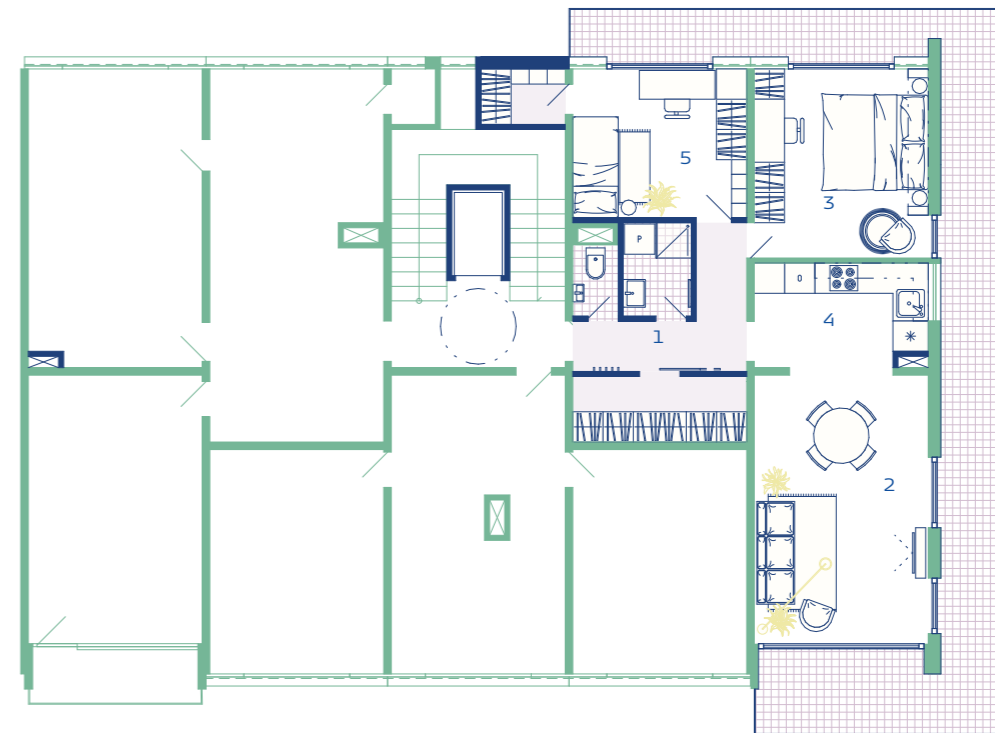

legend:
1 entrance hall
2 living space
3 master bedroom
4 kitchen
5 bedroom



ending section variations

B5/b

original state

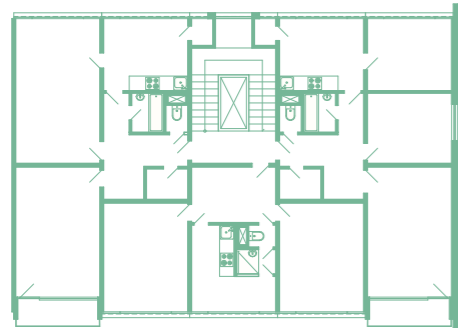

proposed units

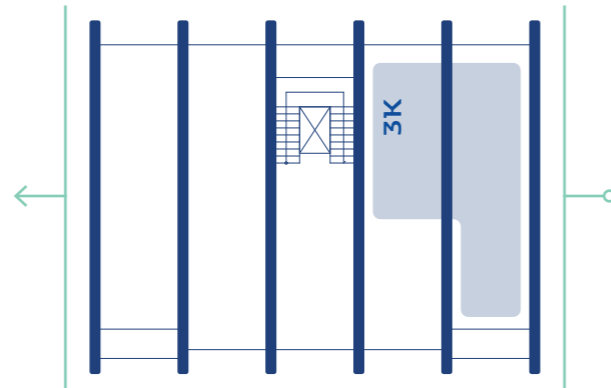

balance
 3K 68m²
 +balcony

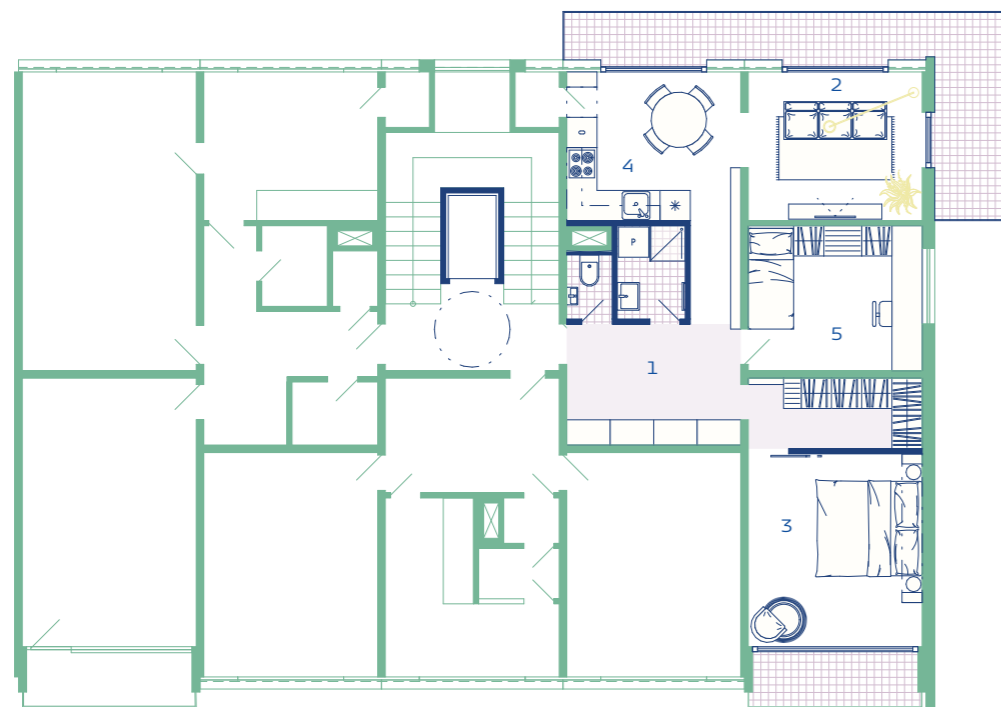
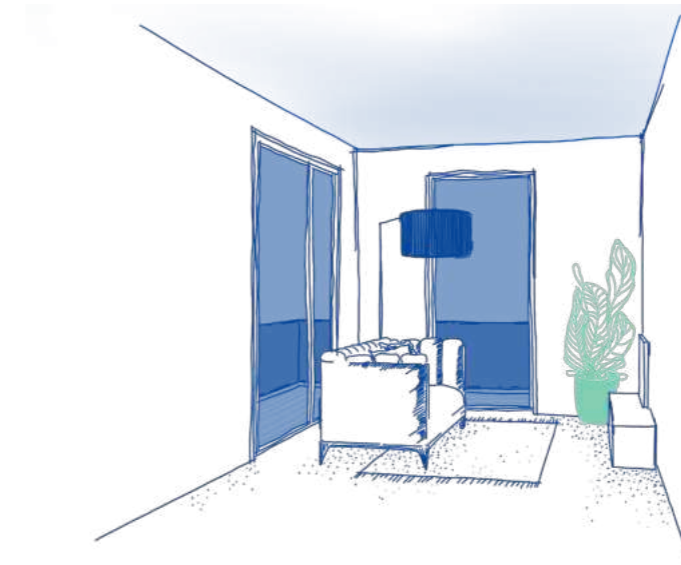

- legend:
- 1 entrance hall
 - 2 living space
 - 3 master bedroom
 - 4 kitchen
 - 5 bedroom



new overhanging structures

B6/a

original state

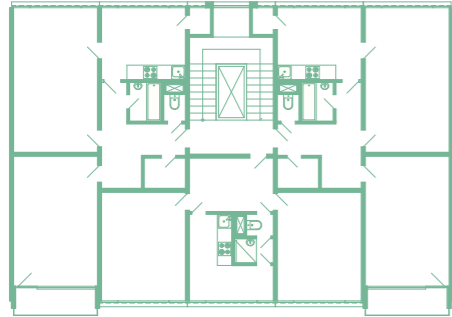

proposed units

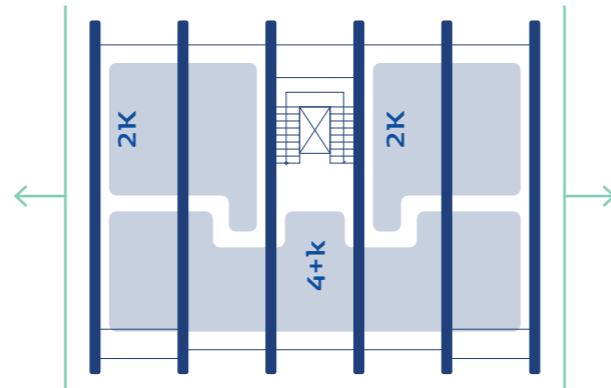

balance

2K	45m +balcony
4+K	95m +balcony +2 winter gardens

font facade

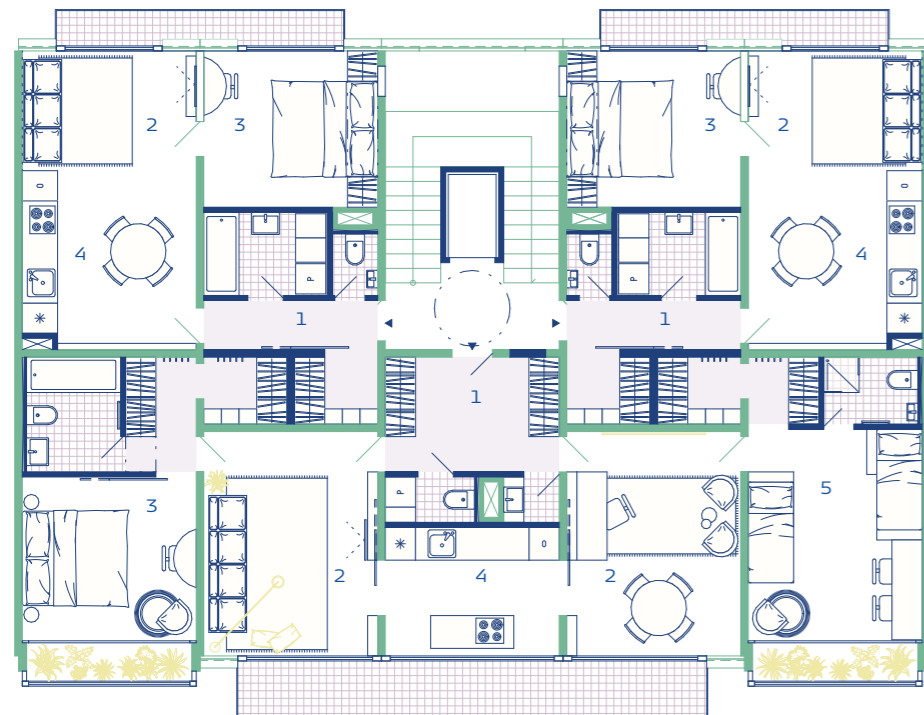
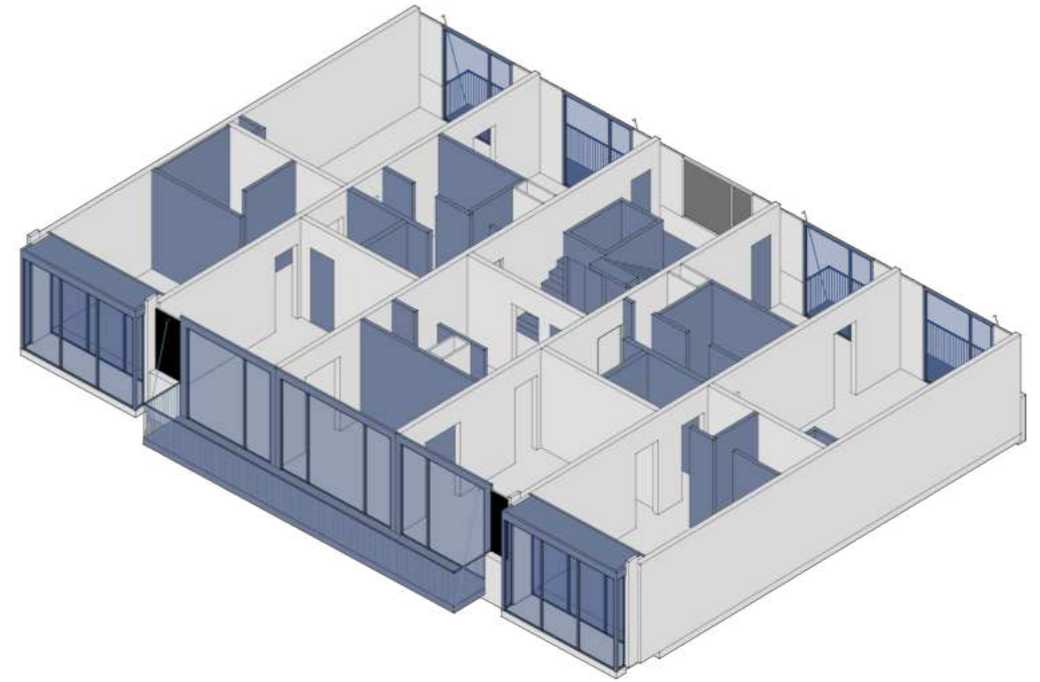

legend:

1	entrance hall
2	living space
3	master bedroom
4	kitchen
5	bedroom



back facade

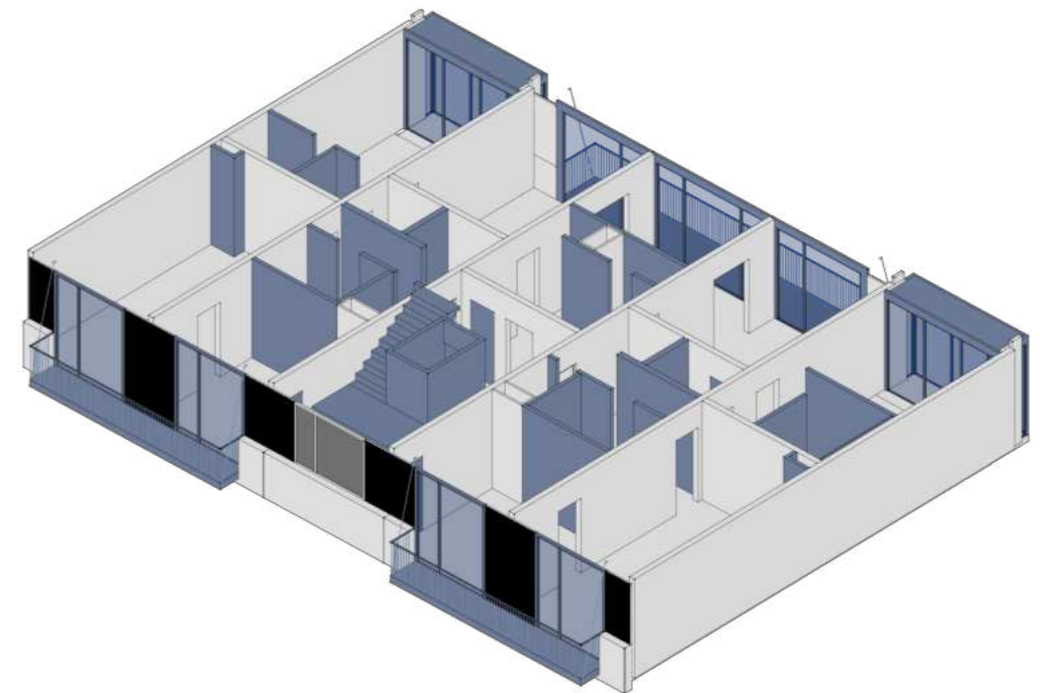

new overhanging structures

A6/a

original state

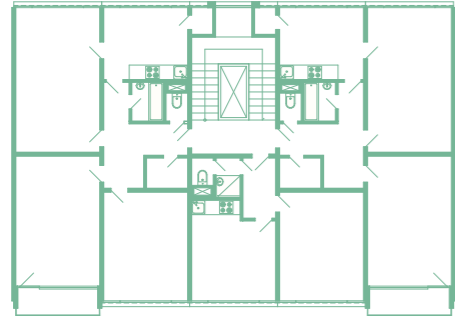

proposed units

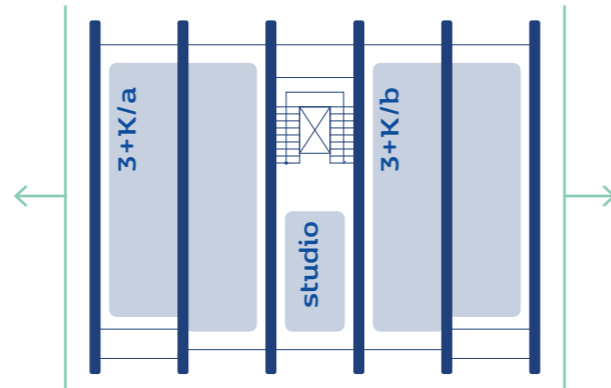

balance

3+K/a	87m ² +balcony
3+K/a	83m ² +balcony
studio	22m ²

new overhanging structures

A6/b

original state

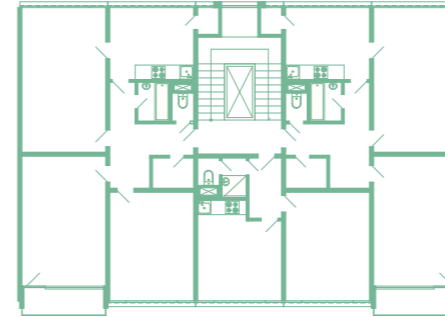

proposed units

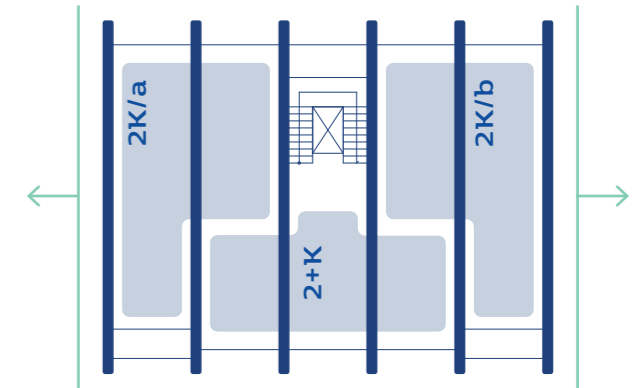

balance

2Ka	65m ² +balcony
3K	65m ² +2balconies
2+K	37m ² +balcony (shared apartment)

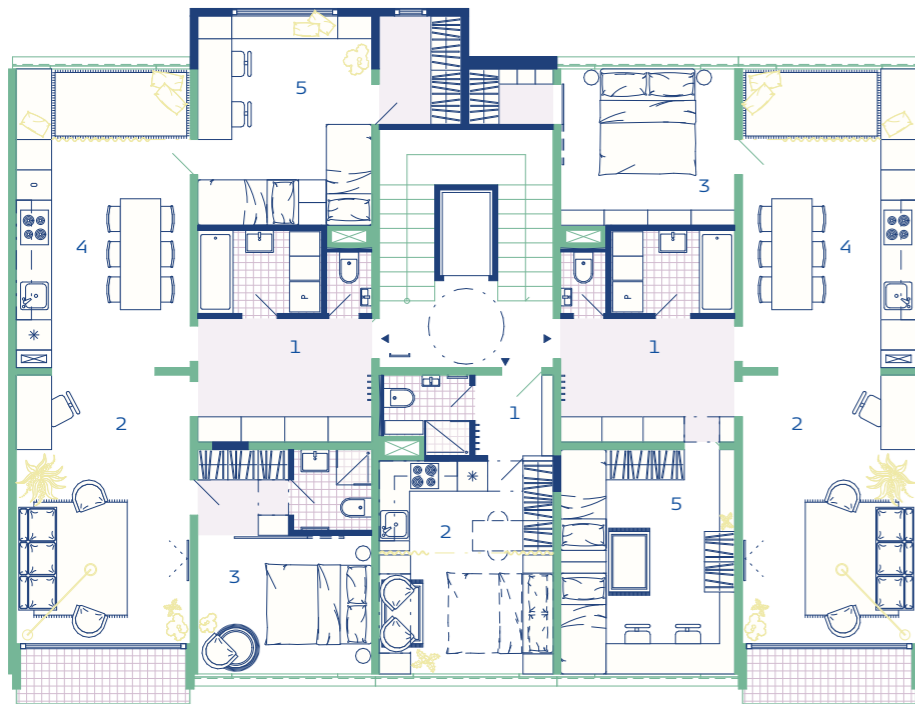

- legend:
- 1 entrance hall
 - 2 living space
 - 3 master bedroom
 - 4 kitchen
 - 5 bedroom

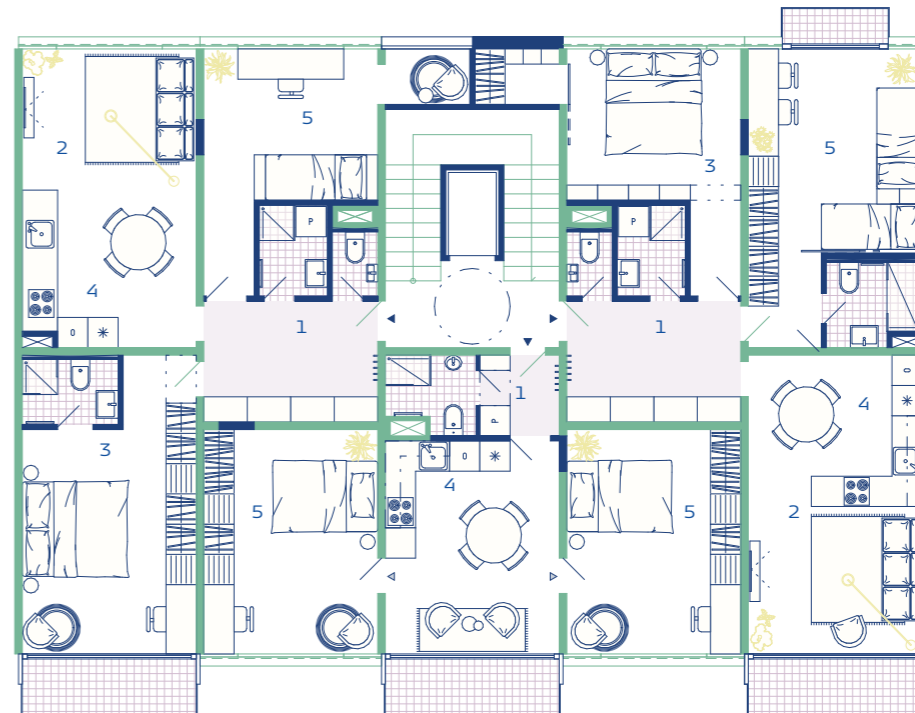

- legend:
- 1 entrance hall
 - 2 living space
 - 3 master bedroom
 - 4 kitchen
 - 5 bedroom



new overhanging structures

C1/a

original state

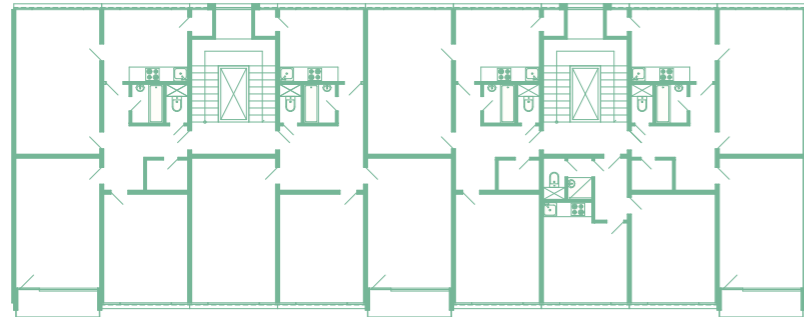

proposed units

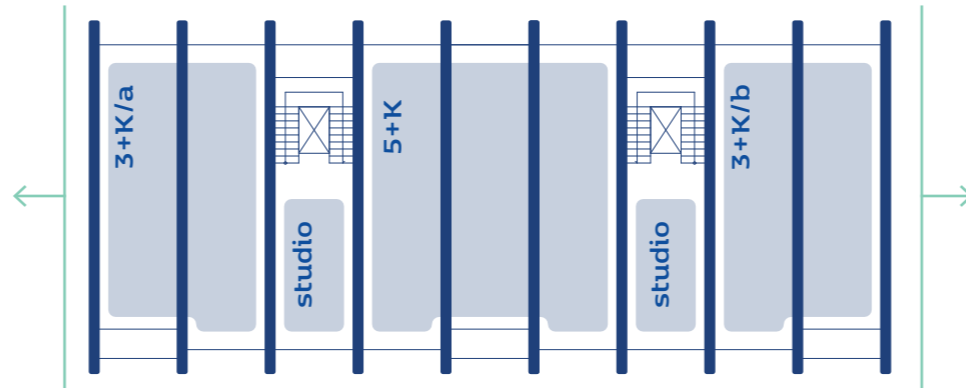

balance

- 3+K/a 83m²
+loggia
- 3+K/b 83m²
+loggia
+ balcony
- 5+K 130m²
+2 balconies
+winter garden
- studio 22m²
+balcony

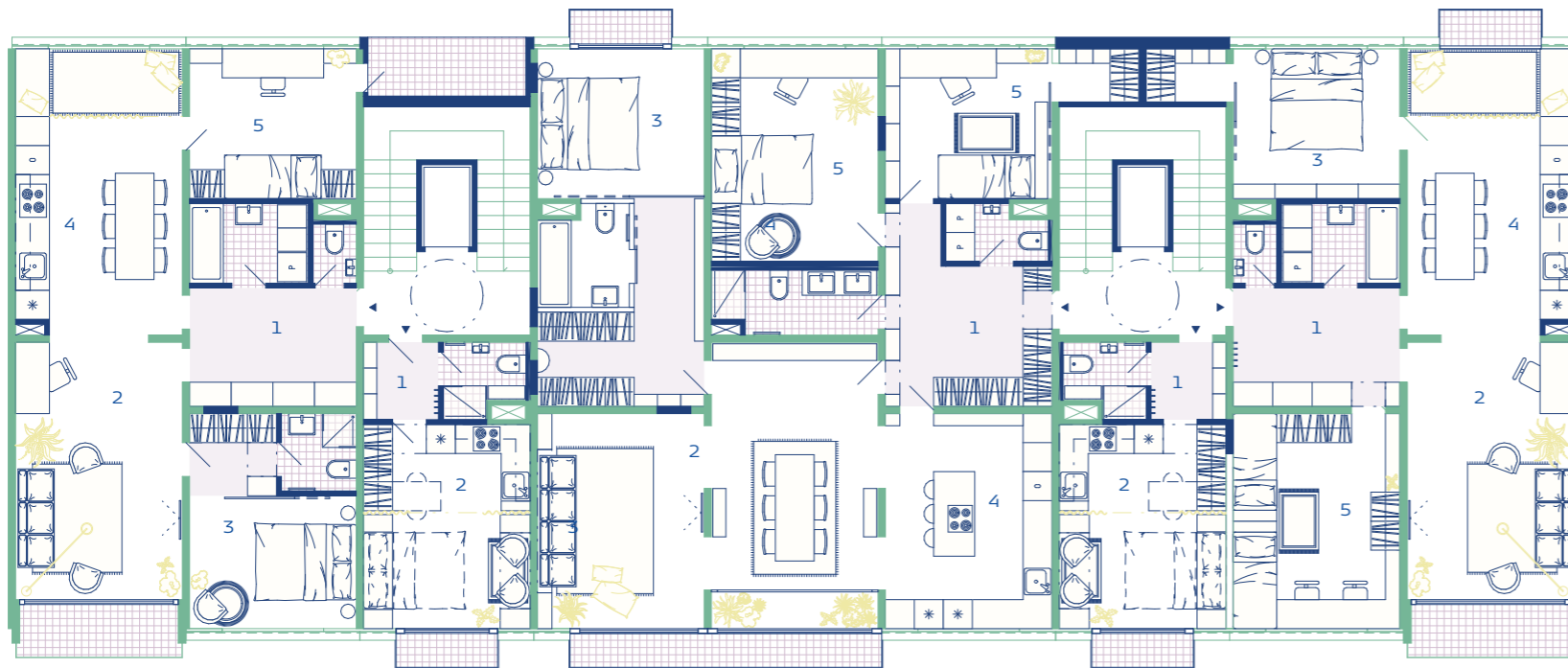

legend:

- 1 entrance hall
- 2 living space
- 3 master bedroom
- 4 kitchen
- 5 bedroom



6.

Application

Františkov

Liberec

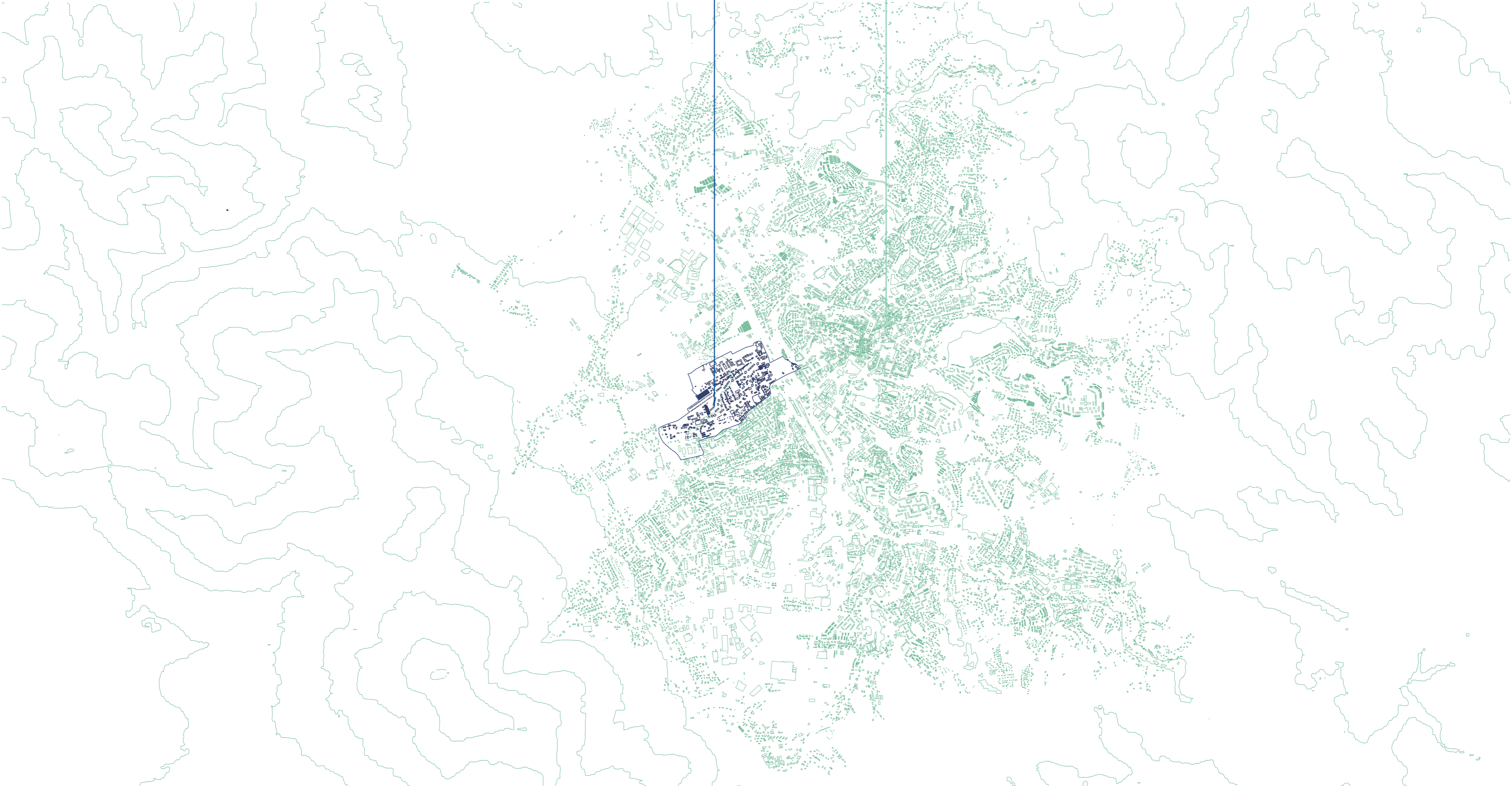

6.

Application

6.

Application

location history and analysis

In the second half of the 20th century, the gradual demolition of historical buildings occurred due to the construction of a road bypass and a railway viaduct, resulting in the almost complete disappearance of the original buildings in the eastern part of the former Františkov. An extensive garage complex of Public Transport for Liberec and Jablonec nad Nisou was built in the northern part of the area, which is still in use and has been expanded several times.

After the revolution, the reprivatisation of industry and factories in Františkov happened in Czechoslovakia. The Textilana buildings ceased operations with the demise of the company itself. At the beginning of the 21st century, a tram depot was built, leading to the further demolition of historical buildings.

The urbanism of the panel housing estate remains

The housing building is located in Liberec, in the Františkov district. The area is situated in the western part of the statutory city, beneath the Ještěd Ridge.

Historically, Františkov, which is now part of Liberec, developed as an independent municipality. The first mentions of settlement in this area date back to the 13th century, when buildings were constructed for the extensive village of Růžodol. The independent municipality of Franzerdorf (later Františkov) was founded in 1657 in honour of Franz Ferdinand Gallas. During this time, the textile industry and agriculture expanded in the area.

During the Industrial Revolution, Františkov was merged with the municipality of Rosenthal, gaining autonomy in 1883. The village experienced great development after World War II when the Czech municipal kindergarten and elementary school, municipal library, and water supply were gradually built.

After World War II, in 1945, Liberec became a statutory city. That led to the annexation of eleven independent municipalities, including Františkov, into an area called “Great Liberec.” Since then, it has been referred to as Liberec X – Františkov. Industrial production resumed in the area, with dominant industries including chemicals, bakery machinery, and soap production. Later, the industry was nationalized under the communist regime.

In the 1960s, a panel housing estate began to be built along Jáchymovská Street, with a total of 1074 new apartments. Alongside the construction of the housing estate, the elementary school was expanded, including the construction of the first school swimming pool in Liberec.



Panel house in Švermova, Liberec^{xi}

unchanged to this day. One residential building is allocated for the municipal police station. The entire urban district has experienced a gradual outflow of residents since the beginning of the 20th century. Public amenities have been continually supplemented with two new outdoor sports facilities, one of which is a revitalization of the original softball field built in 1980 on Krkonošská Street. Additionally, two grocery stores have been established, and a sports store has replaced the original grocery store. In 2022, dilapidated buildings of the former Textilana company were demolished, and new residential buildings are being constructed in their place.

Most residential areas are currently situated between Švermova and Jáchymovská streets. An area of private villas from the first half of the twentieth century was interspersed with panel housing blocks. This symbiosis of two completely different residential structures creates problematic relationships in certain places.

The villa development features private green spaces in the form of gardens for individual properties. The panel housing blocks are set within green spaces, which are limited in Františkov. Orientation and placement of the panel buildings are dividing the surrounding greenery into small patches interspersed with pedestrian pathways and parking spaces.

The proximity to numerous industrial areas and factories leads to an increased presence of groups of workers, for whom three dormitories operate within the area. An analysis made within the Strategic Development Plan of the city of Liberec identifies Františkov as a locality with a prevalence of problematic and socially disadvantaged population groups.

The entire area lacks a common connecting element. While there are many qualities in terms of civic amenities, some elements to which residents could easily relate are missing. Public spaces around individual buildings appear as no-man’s-land, where necessary parking spaces and recycling bins are located. Sports facilities belong to educational institutions. They are accessible to the public under certain conditions, but the surrounding public space does not interact with them or respond to them in any way. The entire area could benefit from the proximity of the sports airport and organizations associated with it, as well as from the ideal accessibility to the



Former Sofia Cinema close to one of the first high rise panel building^{xii}

Ještěd Ridge and the Ještěd sports complex.

Panel housing blocks can provide living space for a broader range of residents. Currently, most of the apartments are of lower standards. It is possible to utilize the advantages of the environment, such as the beautiful view of the Ještěd transmitter, which most properties currently overlook. Additionally, the proximity to the city centre and the train and bus stations could attract residents commuting to work in Prague (by bus) or Dresden (by train).



School sports area Františkov, Liberec^{xiii}



The panel houses were inserted into the villa development from the first half of the twentieth century. Linear residential panel buildings were constructed using the T06B system, while the T08B system was used for point and high-rise residential panel buildings

The civic amenities are cumulated around the local kindergarten and primary school along Švermova Street. There are two sports fields and a centre housing private medical practices in the area. There is only one larger grocery store in the northern part of the area, and nearby, there is also a small convenience store.

In the southern part of the area, there is an industrial zone and the depot of the Public Transport Company of the City of Liberec and Jablonec nad Nisou.

The area also includes apartments, a guest-house, and workers' dormitories. Significant areas are dedicated to above-ground garage buildings.

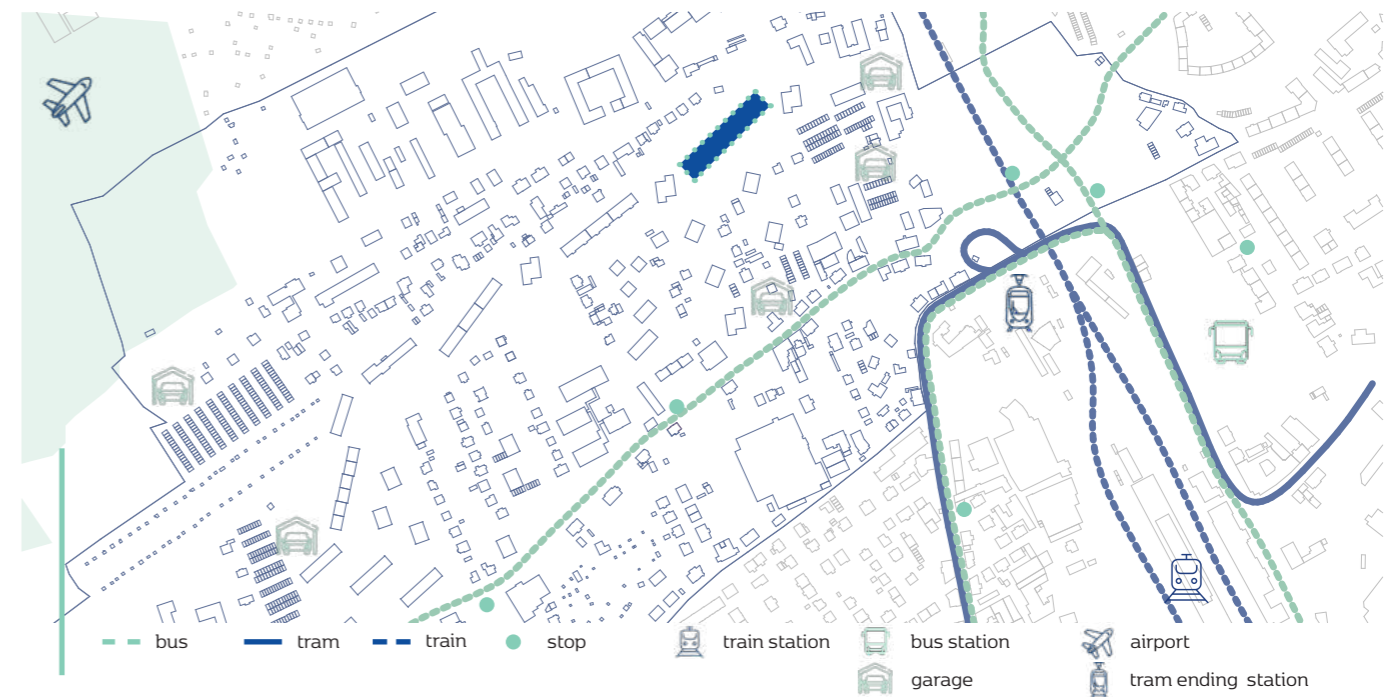
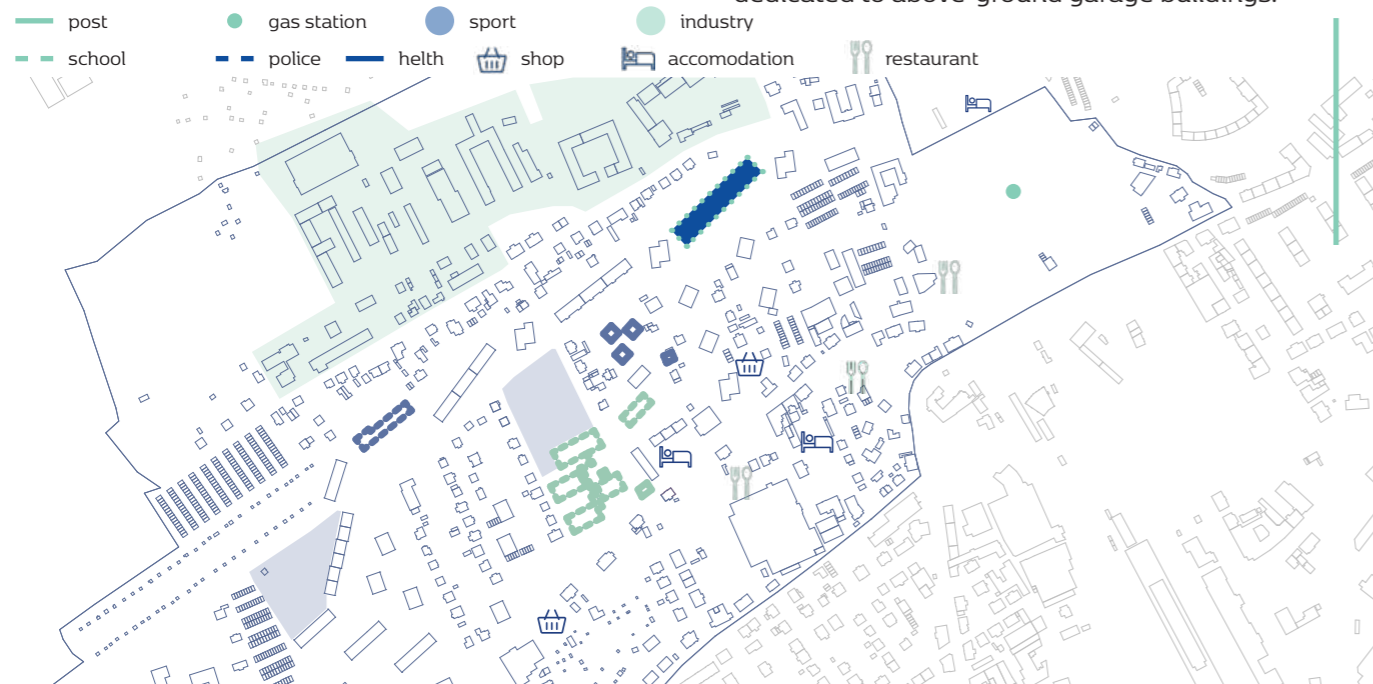

The housing estate is connected to the public transportation network in Liberec via a bus line on Švermova Street. Tram lines run through the western part of the area. No public transportation lines are passing through the northern part of the area. The main train and bus station and the sports airport are located near the area.

The greenery in the area is primarily private, in the form of gardens of family villas or courtyards of apartment buildings. Public green spaces complement the areas of sports fields.

In the western part of the area, there is the space of the former Bosch villa, which is now forested. The borders with an extensive area of the airport's departure grass runway. There is no direct connection to the countryside.



6.

Application

existing structure analysis

region. They consist of parapet panels complemented by bands of windows with window inserts. In this case, the inserts are covered with metal sheets. The balconies are fully embedded in the façade, with slightly protruding floors (360mm from the edge of the façade panel). The railing is a steel structure with glazing. Above the last balcony is a canopy of the same dimensions as the part of the projecting floor at the level of the window opening transom.

One section consists of five modular parts. The entrance is in the central part, with a two-flight staircase on the opposite façade. An elevator is placed in between the two staircase flights, with its shaft ending positioned on the flat roof of the building. The staircase is prefabricated concrete with a surface finish of cast terrazzo. It is set back from the façade and illuminated by windows facing a skylight passing through all floors. The skylight is framed by storage spaces, which are part of the residential units, replacing the structure of mezzanine balconies or storage spaces often designed in T06B systems. Each floor has entrances to two or three residential units. The structural height of all floors is 2.8m, with a clear height of 2.62m in the residential units. The outer parts of each section have embedded balconies on the side of the entrance façade. In the case of three residential units on the floor, the middle (and smallest) unit does not have a balcony.

The composition of the floors depends on the space. In most rooms of residential units, PVC is used as the floor layer, while some rooms were originally designed with mosaic parquet panels. Cement screed is used in storerooms of apartments. The same screed is used also in all rooms of the entrance floor except for common corridors, which are tiled.

The building underwent a façade renovation, which included insulation and a new coloured plaster. Windows and main entrance doors were replaced. There can be found two reconstructions of bathroom cores in the archives. The rest remained without documented changes.

The building I am dealing with is the highest-placed panel residential building among three similar buildings on Jáchymovská Street in the Františkov housing estate in Liberec. The mentioned three buildings consist of the same footprint and sections of the standardized panel building T06B, adapted for the Northern Bohemia region.

The panel building, designed under number eleven, consists of three buildings separated by expansion joints, each composed of two T06B sections. Each section has its main entrance. Thus, the linear residential building has six separate entrances.

The building has eight above-ground floors, with the entrance floor being the technical equipment/amenities floor. There are housing cellar cubicles for each apartment, laundry rooms, technical rooms, and a stroller room on the ground floor. The following seven above-ground floors contain residential units. Altogether, there are 119 residential units across all sections, ranging from 1+1, 2+1, 3+1 to 4+1 standards.

The entire building is composed of prefabricated elements of the T06B system, characterized by a module of 3.6m between transverse load-bearing panel walls. In contrast to the other two identical buildings on Jáchymovská Street, Building 11 has internal panel walls on the entrance floor. The perimeter walls of the entrance floor are made of monolithic reinforced concrete.

A slight change from contemporary standards can be obtained in the bathroom core walls, which in the case of Building 11, are built of bricks. The same applies to the elevator core, which is also brick-built.

The façades of the building were executed according to the standard created for the Northern Bohemia

Structural details:

Vertical Load-Bearing Structures

I. Floor: Exterior walls: Monolithic reinforced concrete, thickness 220mm (gable walls 290mm) Interior load-bearing walls: Prefabricated reinforced concrete panels, height throughout the floor, thickness 140mm.

II. - VIII. Floors: Interior load-bearing walls: Prefabricated concrete panels with minimal reinforcement, height throughout the floor, thickness 140mm. Gable walls: Prefabricated concrete panels with minimal reinforcement and thermal insulation, height throughout the floor, thickness 225mm.

Horizontal Load-Bearing Structures

Foundations consist of a reinforced concrete slab and concrete foundation strips.

The structure of the ceilings consists of prefabricated reinforced concrete panels with reinforcement, thickness 120mm, span 3600mm.

Non-load-bearing structures

Non-load-bearing partitions in the apartments are built with perforated bricks laid with lime-cement mortar.

The elevator core is constructed with hollow bricks laid with lime-cement mortar.

Facade

Longitudinal façades are formed by parapet strips of panels and window openings separated by inter-window insulation inserts. Parapet panels primarily serve a thermal insulation function and are non-load-bearing, anchored to the ceiling and wall load-bearing panels, with dimensions of 3600x1200x240mm.

The exterior cladding underwent insulation and application of a new exterior plaster.

Window openings

In the residential units, a uniform window opening size is used, measuring height 1600mm, width 2100mm, with a parapet height of 875mm. At the level of the intermediate landing, the window openings have dimensions: height 1600mm, width 1500mm, with a parapet height of 875mm. In the entrance level, openings measuring height 750mm, width 150mm, with a parapet height of 1750mm are used on the same axis as the window openings illuminating the intermediate landing space. The façade on the side of the entrance areas has openings measuring height 1200mm, width 600mm, with a parapet height of 1750mm at ground level. Window inserts and entrance doors were replaced along with the façade renovation. The original wooden frames with glazing were replaced by plastic windows.

Structure of the typical apartment floor

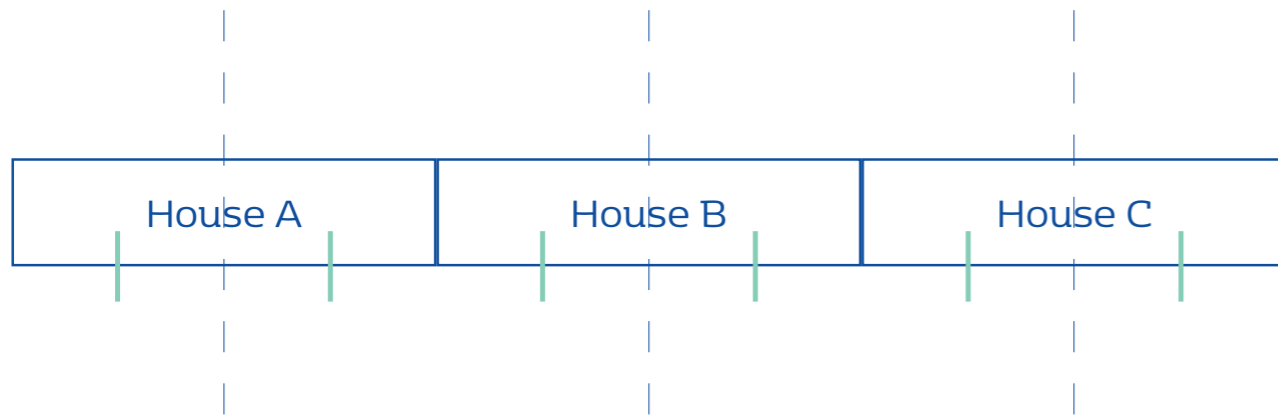
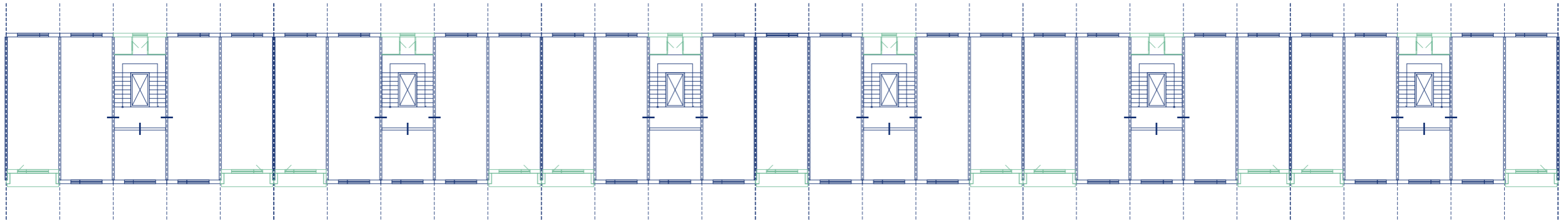

Details of the layout of section types and residential units:

House A	House B	House C
Assembled with sections:	Assembled with sections:	Assembled with sections:
468c and 468b	468c and 468b	468c and 468b
Apartment units n one floor:	Apartment units n one floor:	Apartment units n one floor:
1x 1+1	1x 1+1	1x 1+1
4x 2+1	2x 2+1	4x 2+1
1x 4+1	2x 3+1	1x 4+1
		Conclusion
		21x 1+1
		70x 2+1
		14x 3+1
		14x 4+1
		119 apartments

The current state

Building 11 on Jáchymovská Street currently responds to its surroundings to a limited extent. The land belonging to the building could be utilized more effectively, both for the residents of the building and for the surrounding buildings or visitors.

The space in front of the building serves as an occasional passage for cars, with green areas consisting of small patches of lawns with mature trees. The space behind the building serves only as a connector for pedestrians from the industrial part of the area to the residential buildings.

The entrance technical floor of the building has lost its main use – laundry, drying room, and ironing room with the advancement of technology. These spaces are not used in any way anymore.

The common areas in the individual sections have remained unchanged, with no interventions except some routine maintenance work such as repainting.

No interventions have been made to the structural system of the building. Horizontal and vertical load-bearing panels have been preserved. There are no records in the archives of adding openings to load-bearing structures or their demolition.

The layouts of the individual residential units have remained unchanged. The most numerous are the 2+1 apartments, which make up two-thirds of the total number of units. The area of the residential units is similar to contemporary standards, with the room layout closely linked to the module of the load-bearing walls. Problems can be seen in the inadequate bathroom core and kitchen, which are undersized according to contemporary standards. The residential units have little storage space, and the layout of rooms, the placement of doors, and window openings make furnishing difficult.

The condition of the technical equipment and structural resistance of the building will be the subject of further research.

The façade and roof underwent renovation through insulation. Besides the thermal-technical advantages, this renovation did not bring new value to the building or its surroundings. The colour scheme does not respond to the local context and suppresses the details of the original façade, which was articulated by using different materials and profiled by projecting floors of balconies.

Possible interventions

A new value for the area and the residents of the building could be added by connecting the entrance floor of the building with the surrounding area. Unused laundry rooms offer an opportunity for new functions. The area lacks spaces for young and elderly residents to meet. If we were to consider the location as an attractive place for young couples or families, or so-called “digital nomads,” there would be demand for coworking spaces and an expanded offering of smaller gastronomic establishments.

The space in front of and behind the building could interact with the newly proposed ground-floor function. It could create places for residents to sit, cultivate plants, or play with children. Simultaneously, it could serve as a pleasant place for passers-by and address the placement of recycling stations.

Care should be given to the common corridors, as they are representative spaces of each residential building and a meeting place for neighbours. Unifying the surface material details and marking individual apartments and other spaces could create a pleasant impression.

Interventions into the layouts of individual residential units can be made with consideration for the building’s structural system. Modified layouts should be variable, emphasising well-designed storage spaces and maximizing the use of balconies and window openings for valuable views. Connecting existing residential units, after verifying structural integrity, could be considered when designing new openings within load-bearing panel structures.

Previous references show an increase in the standard of apartments through the expansion of balconies or replacement of parts of the façade. This solution could be considered for this housing building. Creating entirely new balconies on the rear façade is worth considering. Although it is on the northern side of the building, it faces a green environment and opens towards the Ještěd Ridge.

The roof of the building offers the possibility of creating a community space, garden or additional housing spaces if suitable from a structural standpoint. Alternatively, extensive greenery could be considered, which has a positive impact on the local micro-climate and helps retain rainwater in the area for further possible use.

Current schematic section

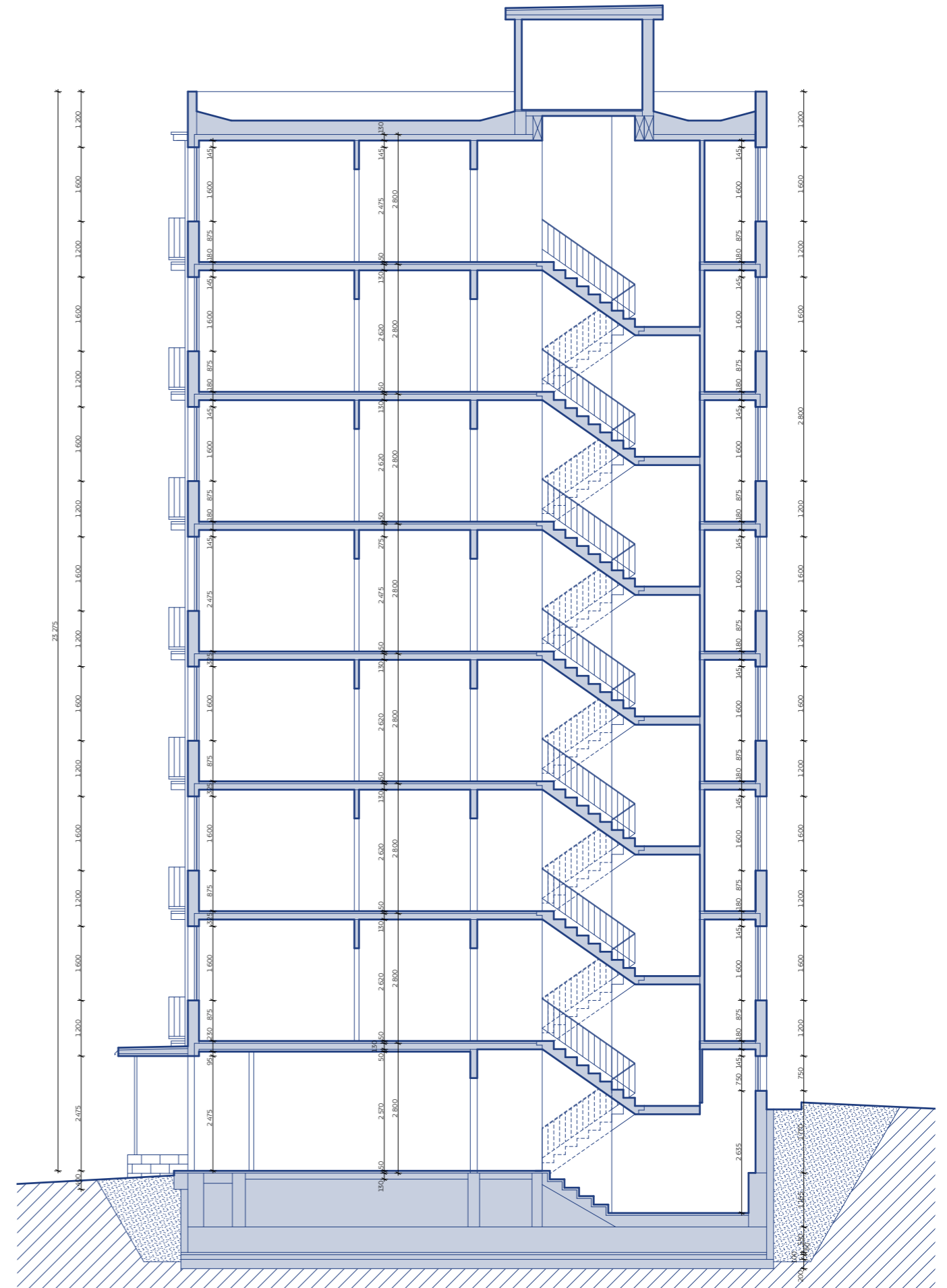

6.

Application
proposal

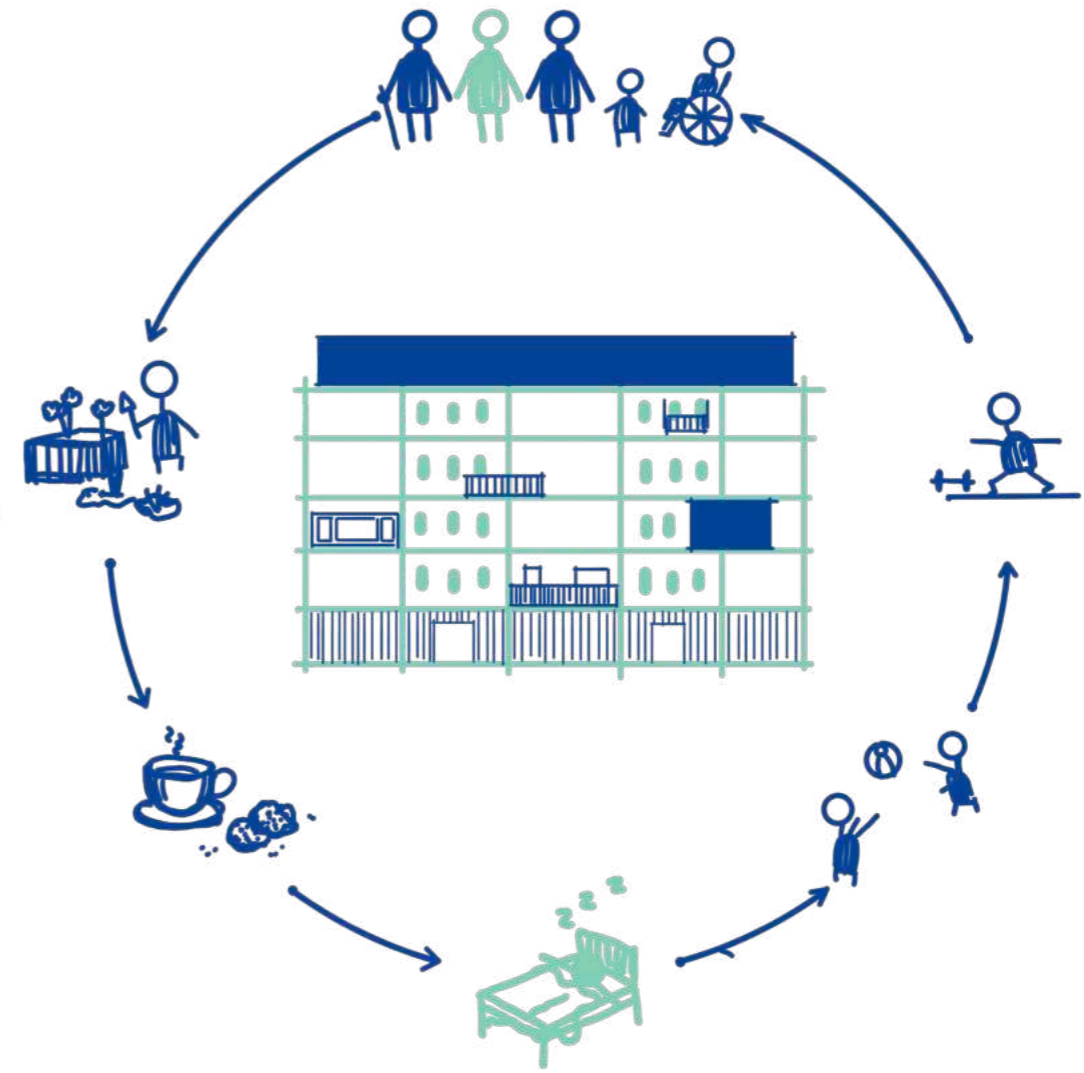
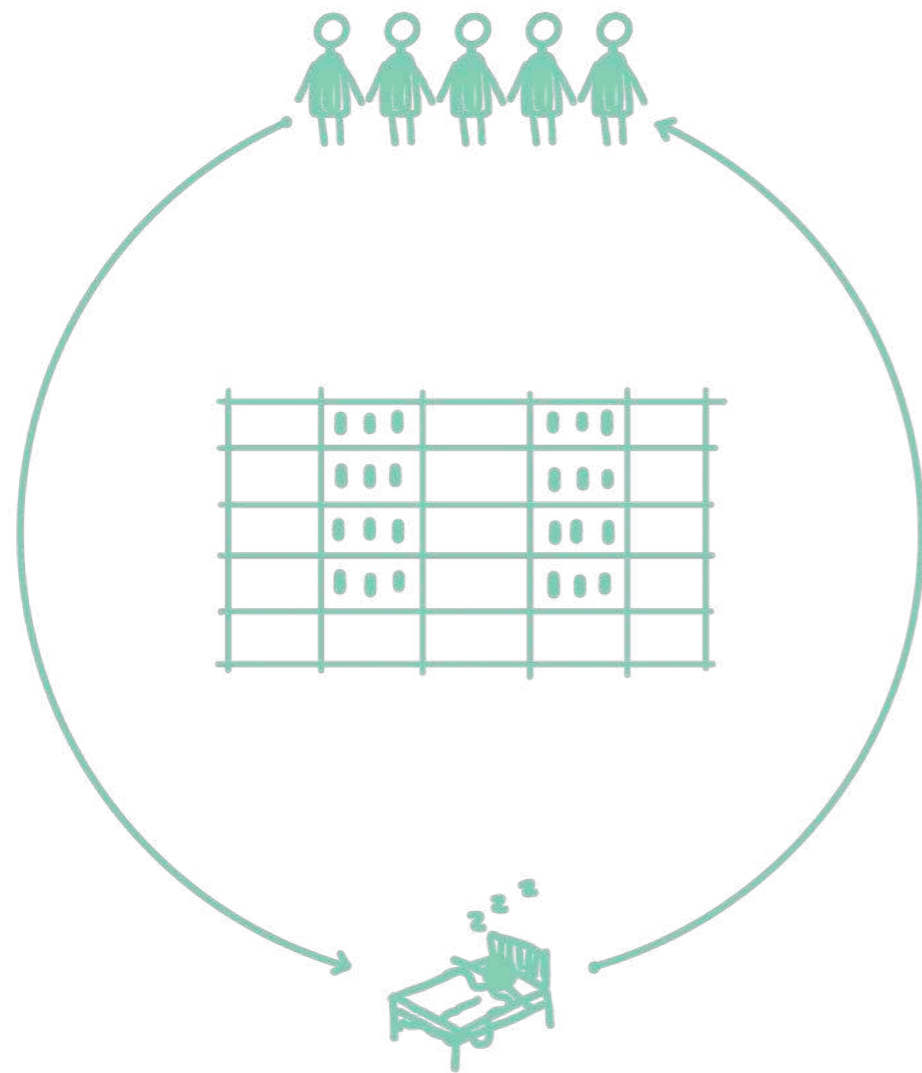



in Františkov. The second public function is a café, which has outdoor seating located at the back of the building, where it is quiet and pleasantly shaded in the summer. The remaining spaces are primarily facilities for residents. There are private storage spaces and rentable storage units. The building has two shared laundries with adjacent outdoor spaces for drying clothes and relaxing. The laundries serve primarily for shared housing, which I am trying to incorporate into the design. The side façades are open to the exterior and include a children's playroom connected to the outdoor playground and facilities for DIY enthusiasts and gardeners.

On the floors with private apartments, I combine the above-mentioned typical layouts of individual sections. I strive for maximum variability and diversity. I emphasize apartments suitable for extended families, which can particularly benefit from the availability of a kindergarten and primary school, as well as a range of sports facilities in the area. On the other hand, I also consider singles and couples, who can take advantage of small studios and shared apartments.

By adding two more floors, I aim to create a better proportion for the currently very long building, provide a better response to the surrounding high-rise buildings, and offer a higher standard of family living. In the extensions, I place units corresponding to two-story family houses, which have private outdoor atriums and, thanks to their placement on the roof of the existing apartment building, offer beautiful views of the forest covered hills surrounding Liberec.

With my design, I strive to bring diversity to the area and provide places where people do not just come back to sleep. I intended to revitalize this part of the city, specifically the housing estate, and offer a reason for both locals and visitors to come and stay for a while.

The Františkov housing estate is currently one of the most problematic areas of Liberec. The outflow of residents is primarily caused by the difficult accessibility, the low level of social services, and the limited opportunities available for different groups of residents. There are many family houses and private villas, which are a desirable form of housing for families, but they are mostly inherited from generation to generation. The only other housing option are prefabricated panel buildings. Many of these are already in very poor condition, while others have been renovated to some extent. However, no interventions carried out so far have had a positive impact on the area as a whole or the residents' identification with their surroundings.

Using the information gathered in this work and the general principles I have created, I strive to intervene in a building located on Jáchymovská Street in the Františkov housing estate in Liberec. I am revitalising the building as a whole in terms of inner layout, façade, connection to the surroundings, and I am using its roof to create extensions for a new standard of living. Through interventions, I aim to offer a wide range of options that appeal to different groups of residents with various needs as well as other people in the area.

A significant change on the ground floor level is the addition of public and private functions. I connect the unused space of the former laundry rooms with the current storage spaces to achieve an optimal distribution of all functions throughout the entire floor. Using the additional structures, I create optimal spaces for public functions. There is a public fitness centre in one part of the building, which follows the sporting tradition and equipment that has deep roots

6.

Application

surroundings and ground floor

situation 1:1000

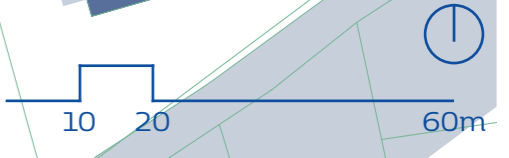
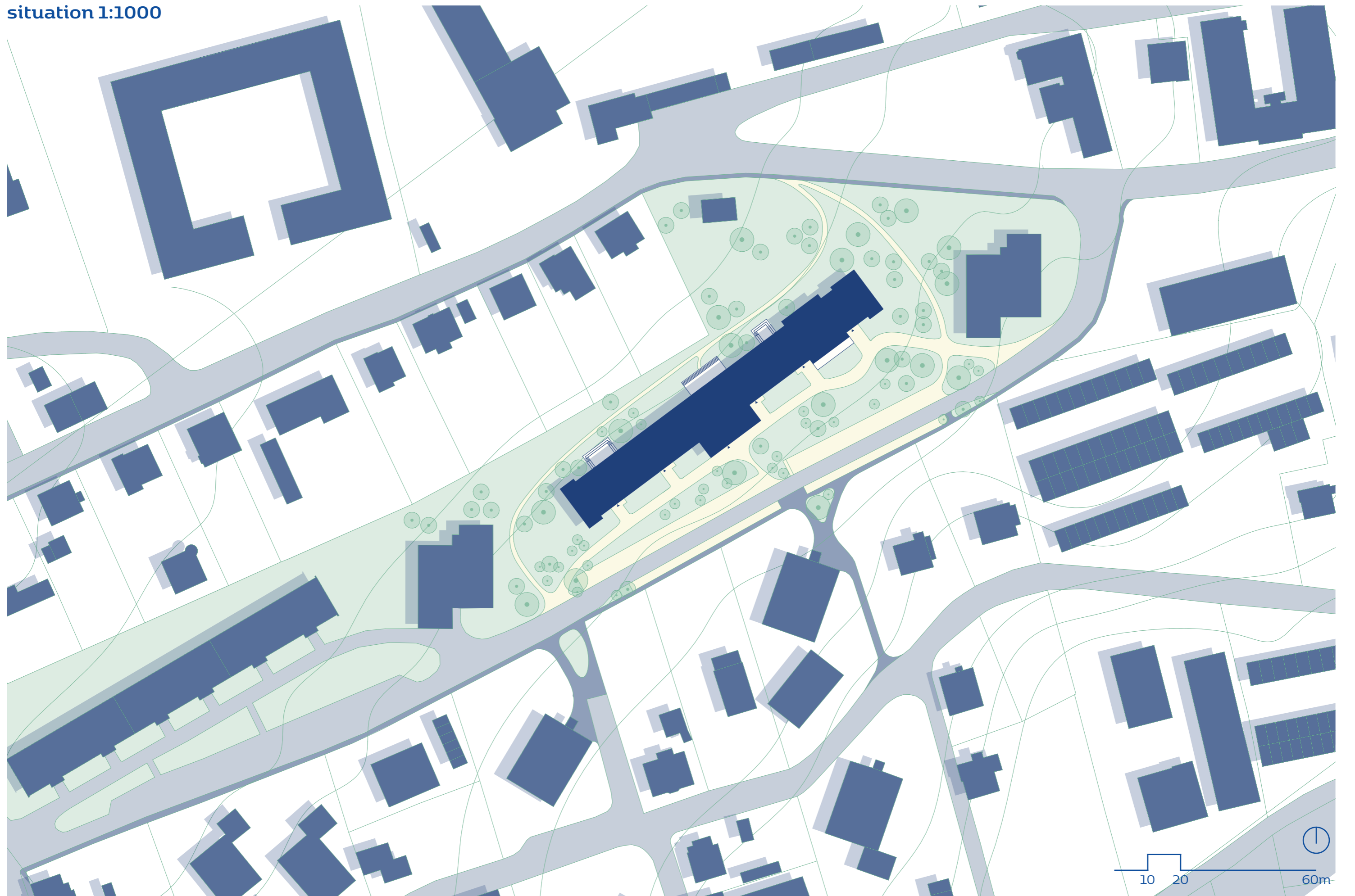

situation 1:500

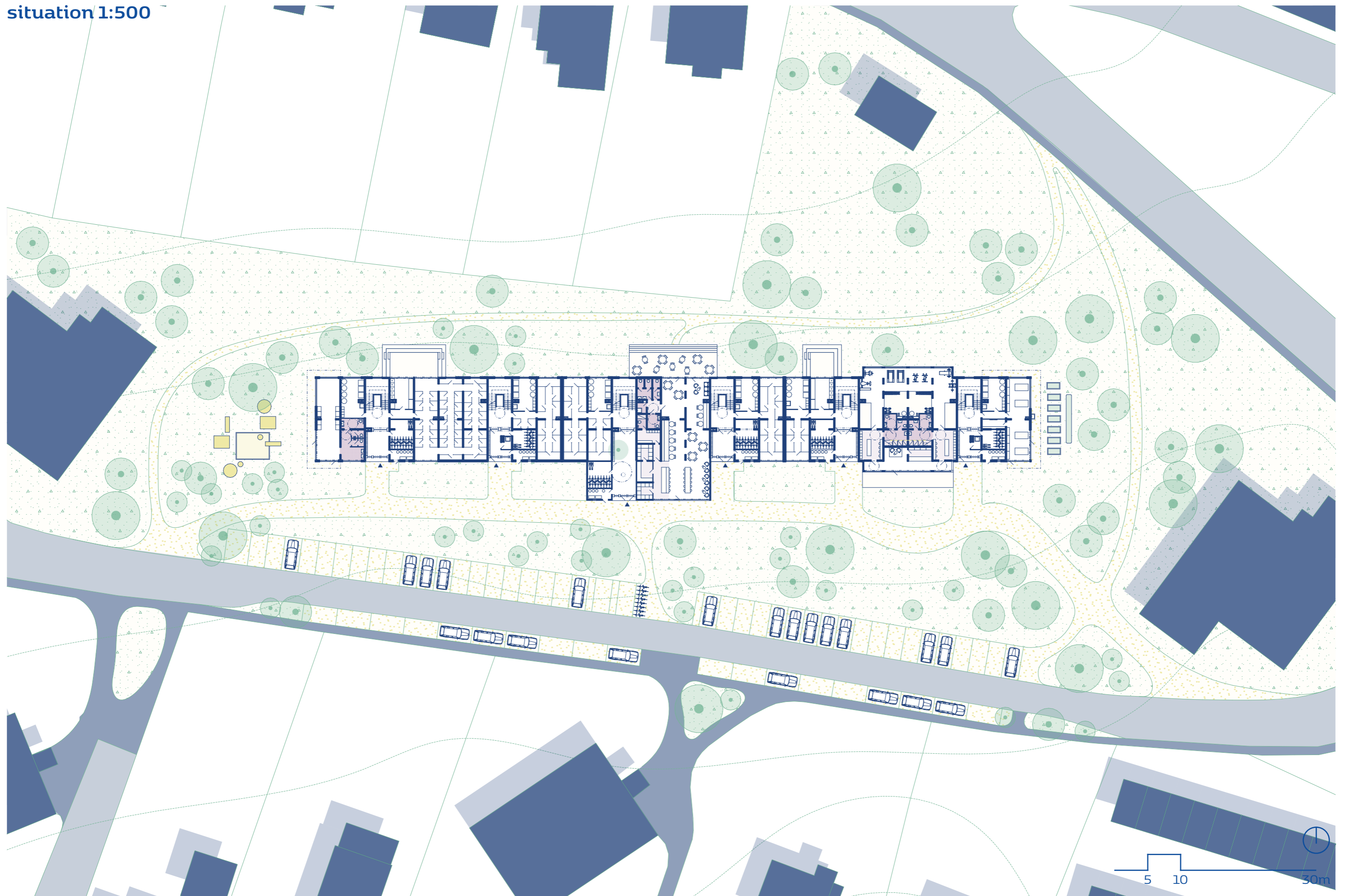



ground floor 1:300

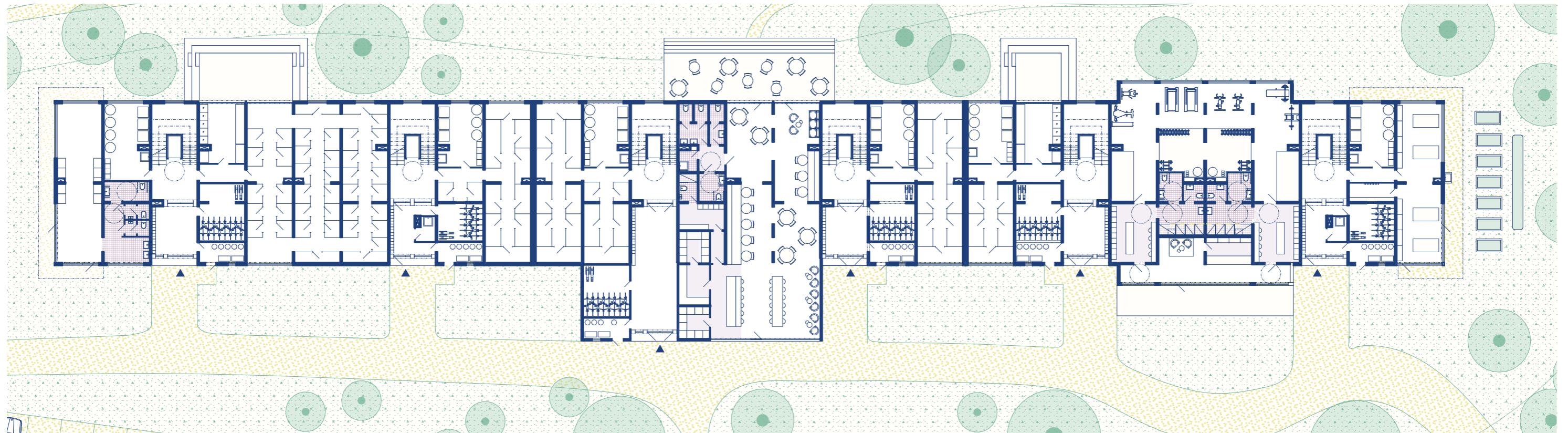
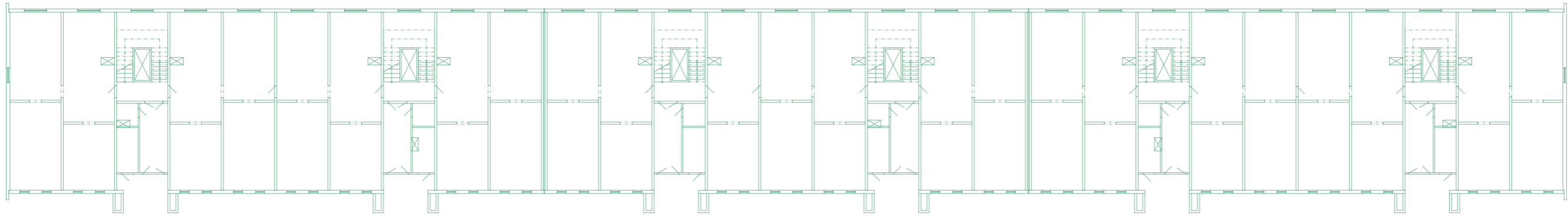

A fundamental change at the entrance floor level includes added public functions. Given the extensive unused spaces of the former laundries and the low variability of storage spaces, I propose a complete revitalization. Using an attached structure, I create a profiled facade that facilitates orientation and highlights the entrances to the residential building as well as the publicly accessible areas.

I propose the new functions based on a local analysis of services and the composition of the residents. The new bistro and café are located approximately in the centre of the building. With the extension, I enlarge the space and open the café to the greenery in front of the building as well as towards the rear facade, where a slightly recessed terrace with seating is created. The second extension creates space for a fitness centre. I open the space at both ends of the buildings towards

the exterior, creating community functions accessible to the residents of the building. The western-facing area includes an indoor children's playroom with direct access to an outdoor playground and sanitary facilities. The eastern-facing area serves as a facility for gardening with direct access to an outdoor space with planters and garden beds for growing crops and flowers.





6.

Application

apartment floors

2nd floor apartments 1:300

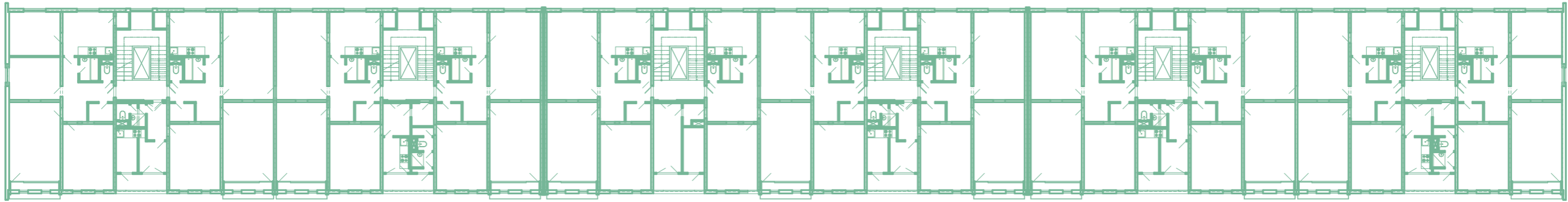

The first floor, which houses the residential units, is atypical mainly due to the protruding structures. Since I am creating protruding structures on the first floor, I am using the roofs on the second floor to expand the residential units and create terraces. The residential units connected to these protruding structures have higher standards and are designed for family living. The apartment above the cafe has the largest terrace shaded by a strip of greenery to ensure the privacy.

On both sides, I create residential units with extensive corner terraces that span the entire side facade. These structures, in turn, provide the desired shade and shelter for the aforementioned functions on the ground floor, namely the children's playroom and the urban farming facilities.

balance:

2x studio
 2x 2K
 7x 3K
 2x3+K
 2x 4+K

3rd-7th (4th) floor apartments 1:300

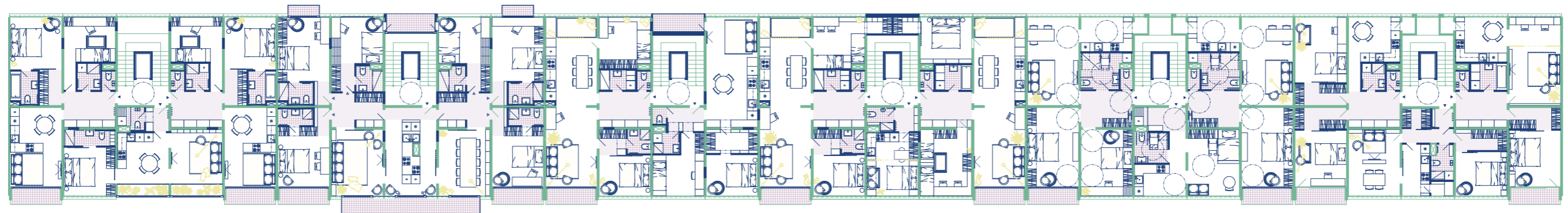
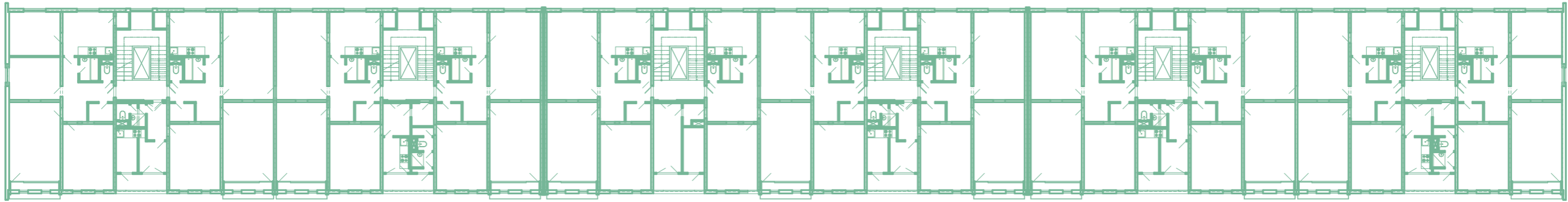

I combine typical layouts created for individual sections on the following residential floors. Considering the initial intention, I place primarily combinations of residential units suitable for families as well as singles and young couples on these floors. I aim for variability and a diverse selection of apartment standards. For example, on the fourth floor, there are classic residential units, residential units adapted for the handicapped and a shared apartment.

The entire building should provide diverse opportunities for different groups of residents with varying needs. The individual differentiations occur both horizontally and vertically.

balance:

A4/a
B1/b
C6/b
A4/a
B6/a



elevation front (south) facade 1:300

original state



proposed state



elevation back (north) facade 1:300

original state

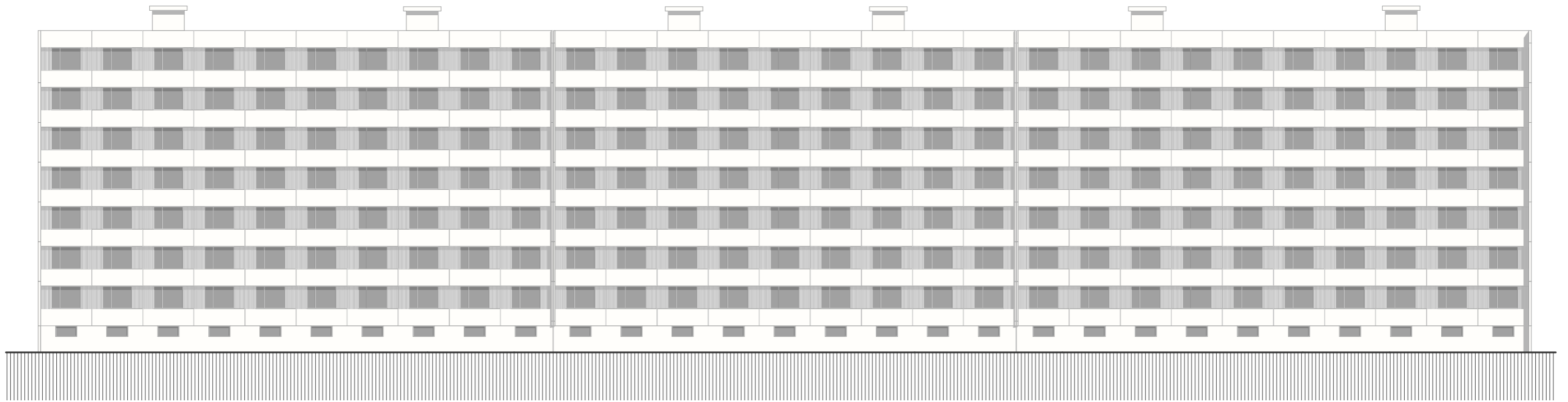

proposed state

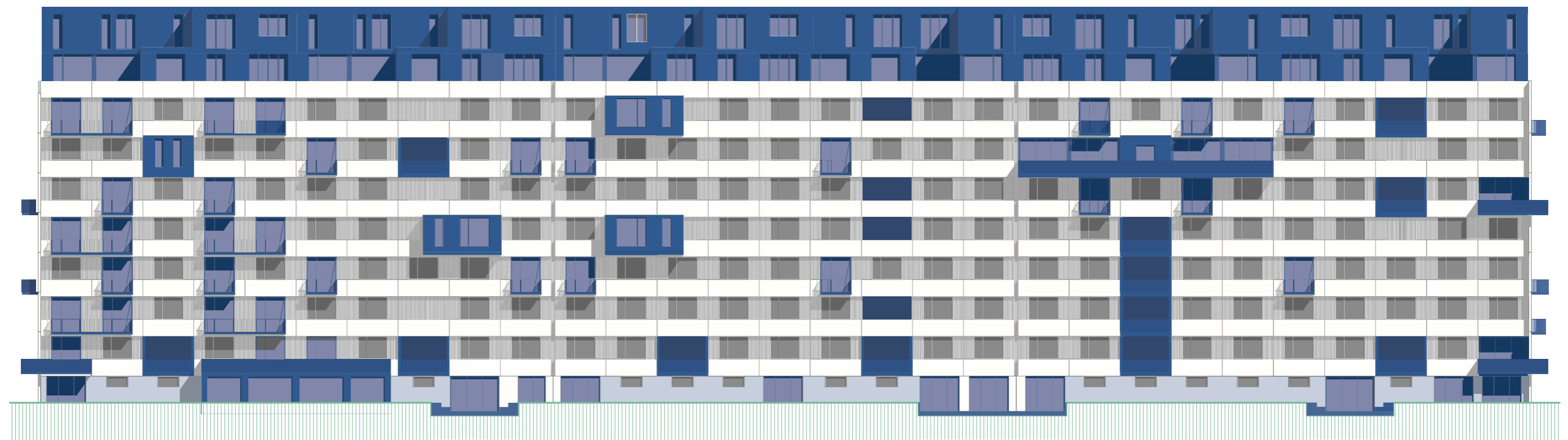

elevation side façades 1:300

original state

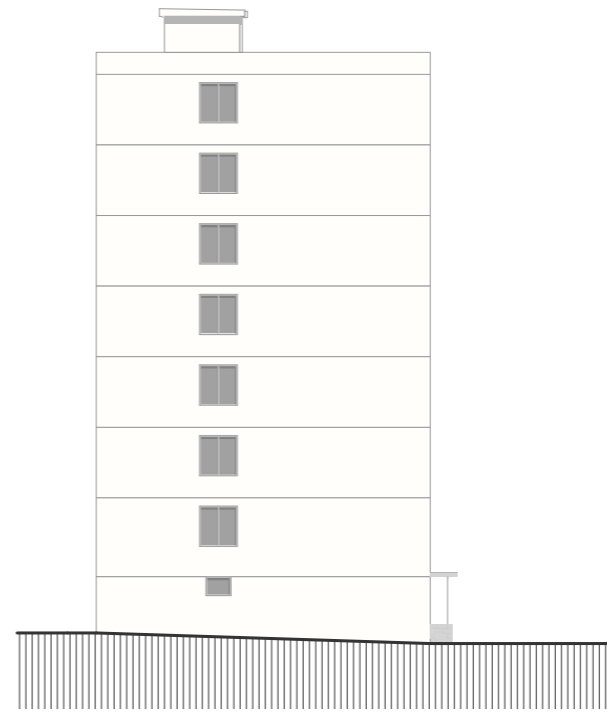
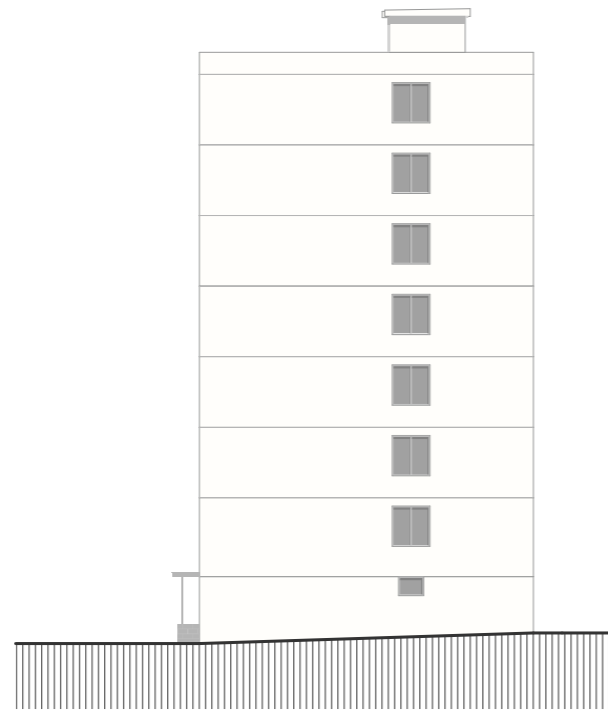

proposed state

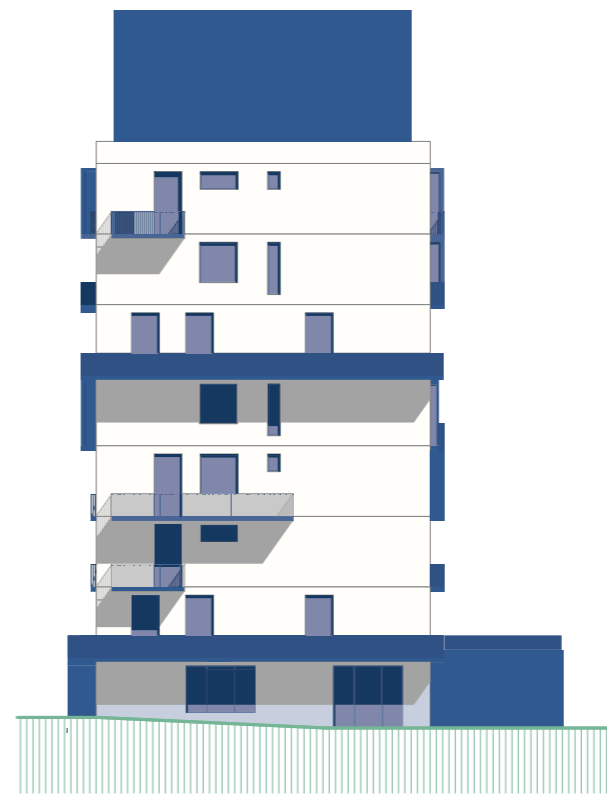

6.

Application
roof extension

roof extension (8th and 9th floor) 1:300

first level



second level

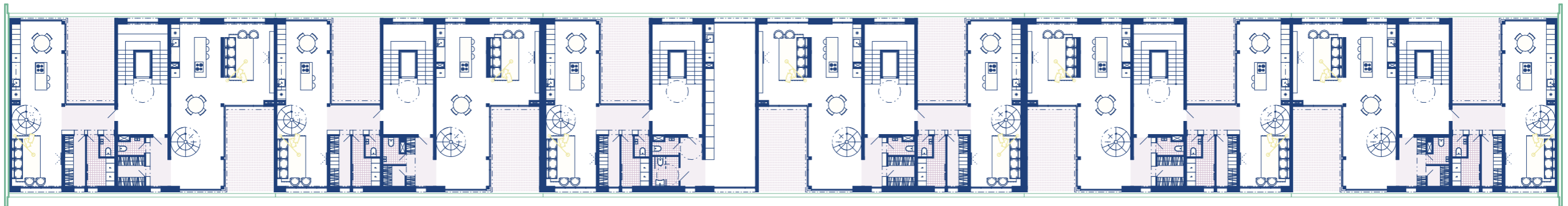

The additions above the roof level of the existing building are conceived as separate family houses placed on the roof of the panel building. Each staircase provides access to the individual units on the eighth and ninth floors. Each family house has two floors. The first level always houses the common living areas, which open onto a private interior atrium. The second level contains private bedrooms, possibly a study, and guest rooms. The additions have flat roofs

covered with vegetative greenery and equipped with solar panels. In some of the additions, there is also a community room for the residents of the building with a beautiful view.

balance:

- 5x smaller family house
- 5x bigger family house
- 1x high standard family house
- 1x common room



housing/functions balance

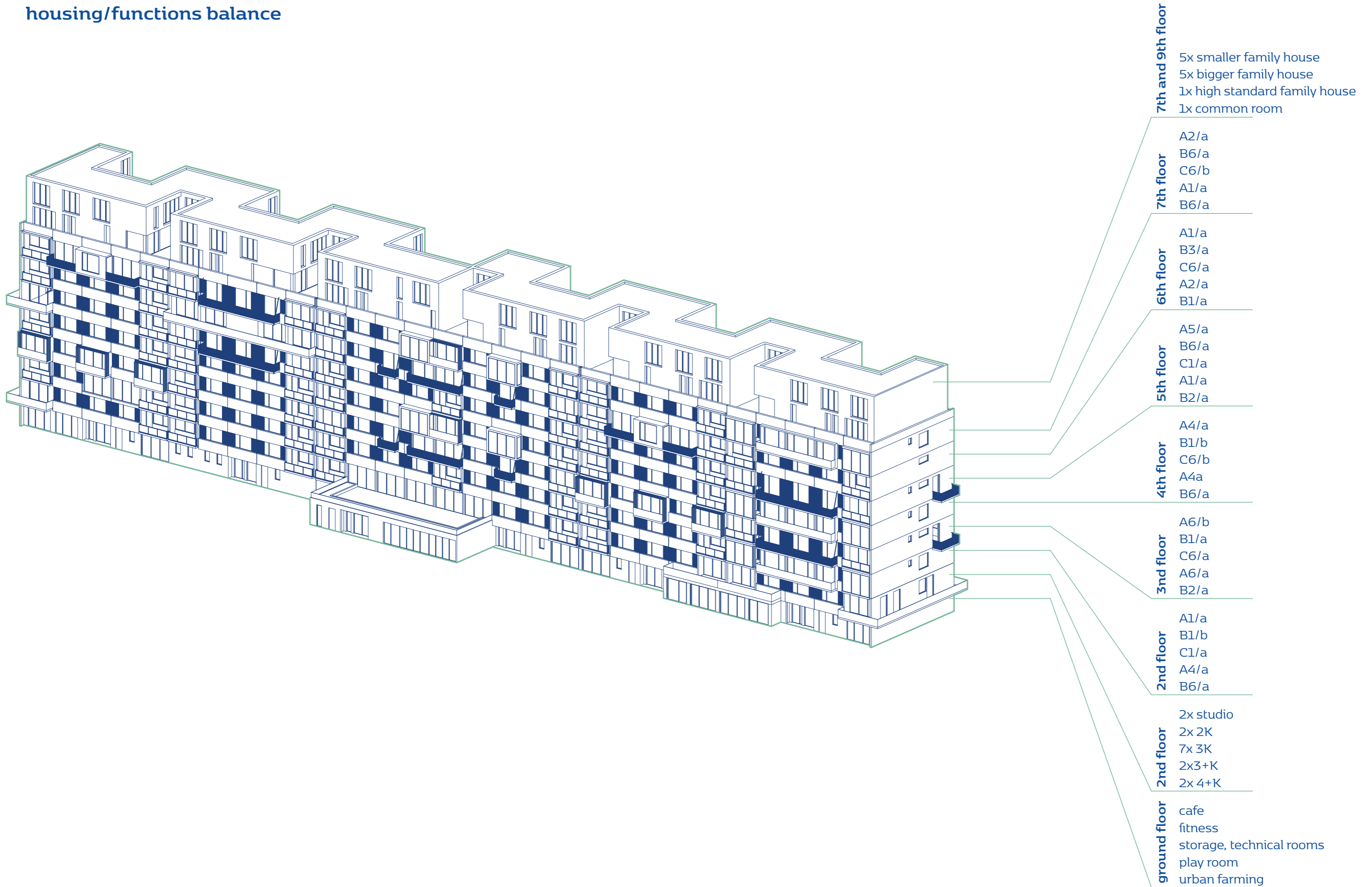

facade detail 1:50

south elevation detail

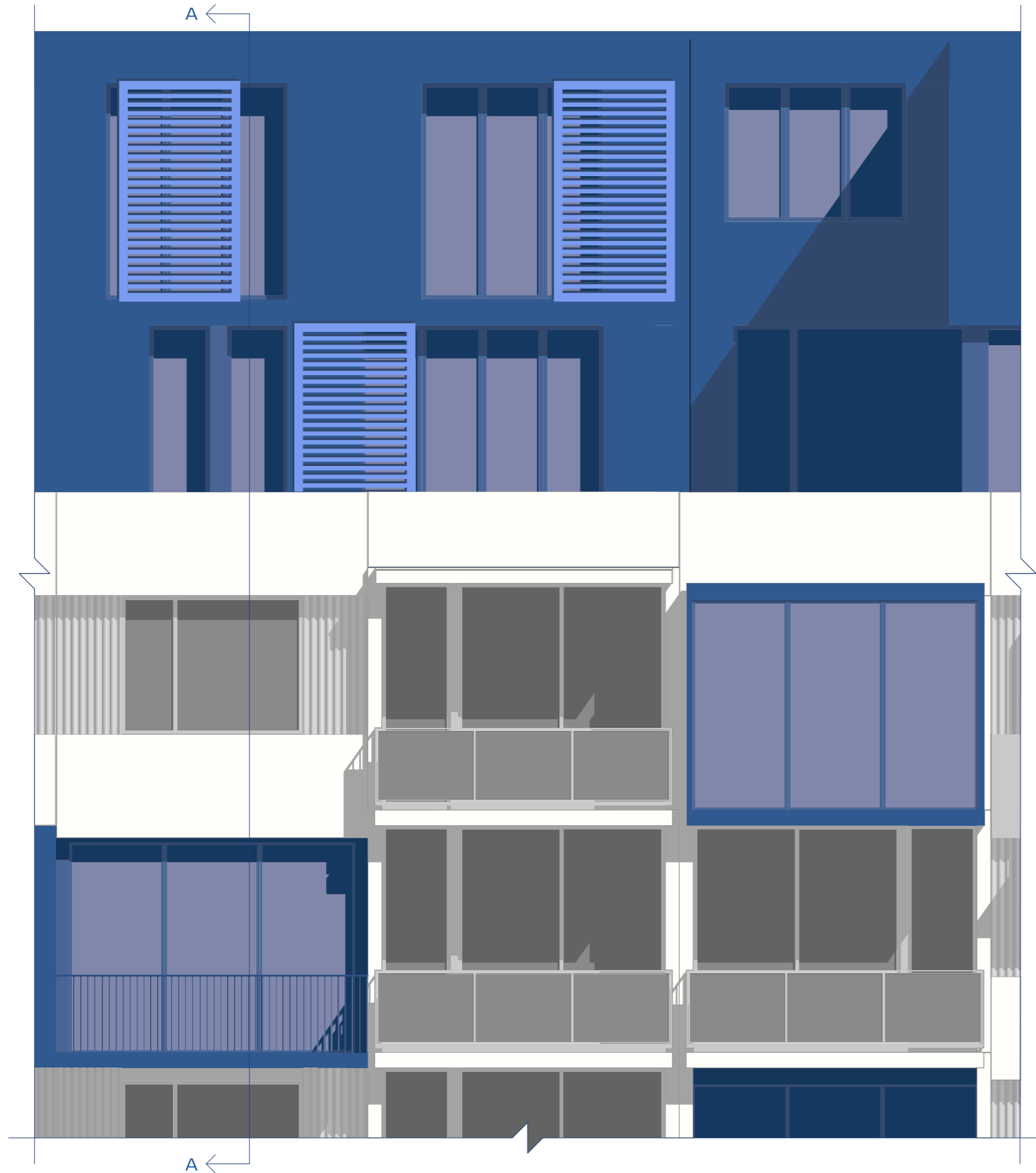

section A-A

wooden facade 30mm
ventilated gap 20mm
hydro isolation
thermal insulation 280mm
interior wooden cladding 20mm

plaster 5mm
additional thermal insulation 100mm
facade panel element 240mm

extensive greenery
substrate layer 150mm
thermal insulation 100mm
hydro isolation
load-bearing steel beam 150mm
installation gap 80mm
wooden ceiling 20mm

wooden tread layer
self-levelling concrete screed 30mm
load-bearing steel beam 150mm
installation gap 80mm
wooden ceiling 20mm

wooden tread layer
self-levelling concrete screed 30mm
thermal insulation 100mm
load-bearing prefabricated panel 130mm

wooden tread layer
self-levelling concrete screed 30mm
load-bearing prefabricated panel 130mm

wooden tread layer
self-levelling concrete screed 30mm
load-bearing prefabricated panel 130mm



6.

Application
sustainability strategies

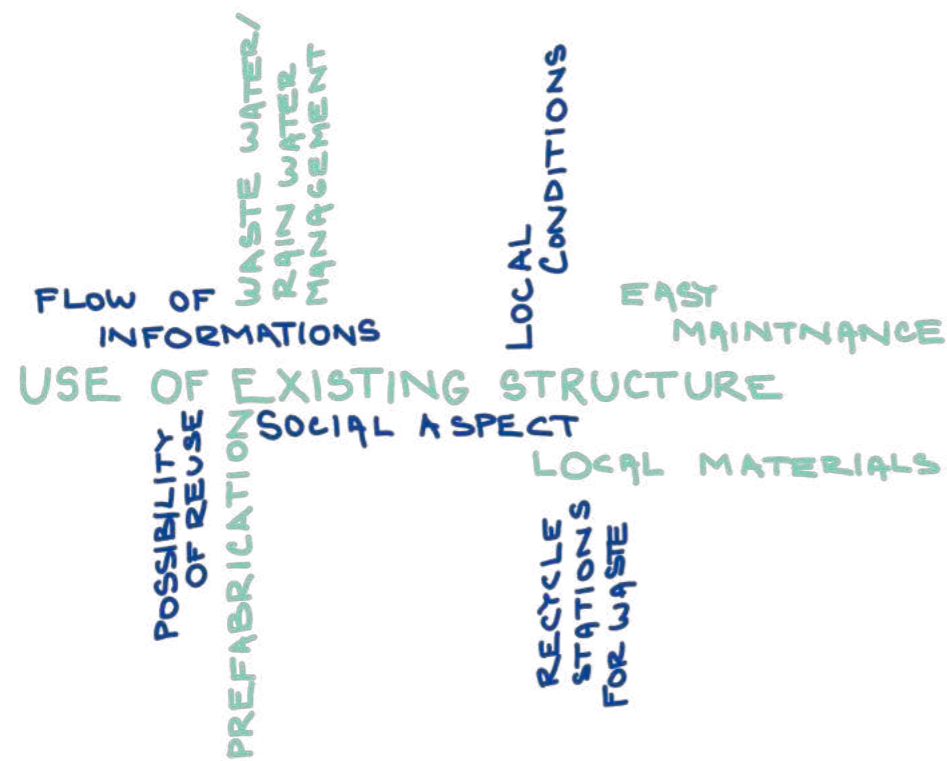

The topic of sustainability is broad and touches many areas. In my design, I strive to integrate various sustainability principles within the overall concept, rather than viewing them as a separate part or an added quality. This topic accompanies my work from the very first decision to deal with an existing building. By thoroughly examining the structure, I aim to identify its strengths and weaknesses and adapt my interventions accordingly. I also consider the target group (or groups) of residents for whom the changes are designed, as the most sustainable buildings are widely used ones.

Another aspect is the values that individual buildings bring to the area. I address this issue through both technical changes and new opportunities and functions. The proposed green roofs of the extensions have the potential to positively impact the micro-climate of the entire area and contribute to better rainwater management. The new public functions of the café and fitness centre will attract a range of residents, participating in public life, information flow, and social control.

A wide variety and diverse offering of standards and types of private residential units can help stabilize resident groups and their mutual interactions. Creating pleasant conditions for all age categories can foster mutual bonds and situations that benefit all parties. Many cases show that the coexistence of older people and young families, as well as students, is very enriching. Creating community spaces where individual groups can meet separately also provides the desired level of privacy.

The overall economic demands of the building are largely tied to its technical aspects. Given the limited scope for possible interventions in the installation of

the most modern technologies, which in many cases can ultimately pose significant problems, I try to approach this issue from a different angle. In areas where I create new balconies and winter gardens, I aim to regulate the heat with new window openings and shading using new overhanging structures. In areas where I do not design new structures, I add an extra layer of insulation with mineral wool and insulating inserts between the window openings to the façade panels. The shading of the windows of the extensions is provided by sliding shading façade elements. In terms of wastewater management, I propose a concept adjustment and create a system for secondary use of water from showers and bathtubs for toilet flushing and other secondary purposes. This solution requires the installation of underground storage tanks where grey water is collected, roughly filtered, and then pumped and used secondarily. I also design tanks for collecting rainwater, which can be used for irrigation or absorbed directly in the area.

An aspect of sustainability in the scale of newly proposed structures is the materials used and the system of prefabricated execution of individual elements. The possibility of dismantling elements, replacing individual parts, and subsequently reusing them is a significant topic for me. I try to create all the elements of the new balconies by combining prefabricated components made of wood and steel, which can be assembled and disassembled. I follow the same principle for the construction of roof extensions. Statistically, it is a steel frame structure filled with lightweight plasterboard partitions to minimize the possible load on the existing structure. The façade consists of wooden cladding with a ventilated gap and insulation made of cork boards. The roof extensions have a cover of extensive greenery that can also help with the insulation.

7. Conclusion



7. Conclusion

The findings of this thesis highlight that panel buildings are a multidisciplinary topic, viewed from various historical, social, and architectural perspectives. Understanding the historical contexts that led to the early stages of housing estate construction allows us to appreciate the considerations of both experts and the public at the time. This historical insight helps explain why these structures, often hastily labelled as inappropriate or anaesthetic, came to be.

In the Czech Republic, panel buildings quickly provided homes for hundreds of thousands of families. Despite the industrial production constraints, architects and builders endeavoured to improve housing conditions by designing new systems and learning from past mistakes. Their creativity led to successful implementations where people lived well and continue to do so today. The industry faced challenges such as ideology, propaganda, and the complexity of promoting individual opinions during a period of collective ownership and thinking.

The era in which panel buildings were constructed significantly influences their perception among professionals and laypeople. The ongoing debate about how to address these buildings now and in the future is crucial. Detailed analyses of individual systems and specific buildings reveal comprehensive values and potentials for transforming these structures for new uses or improving existing conditions. Conversely, neglecting maintenance or allowing these buildings to age without intervention poses significant risks.

One major criticism of panel buildings and housing estates is their limited integration with the local context. Interventions should aim to connect these buildings with their surroundings in a better way.

However, this does not preclude the development of universal solutions applicable to multiple buildings of the same type. It is feasible to formulate a set of ideas for the future development of specific systems.

Addressing the problematic aspects of panel buildings involves exploring future uses that accommodate the modified needs of residents or introduce new functions. By offering a wider range of housing standards and public functions within existing buildings, we can enhance their inclusivity and attractiveness. A comprehensive plan of interventions, ranging from small local changes to complete building revitalizations, can bring about positive changes in diverse situations and contexts. Various solutions can address multiple problems. It is advisable to combine individual insights and adapt them to local conditions and the needs of residents.



T06B panel houses in the Františkov housing estate in Liberec during the 1970s^{lv}

research

historic development
archive drawings

analysis

references

evaluation

comparing the collected
informations to current state

proposal

creating ways to deal with the
researched problems

application

verifying the proposals on one
specific example

8. Sources

Printed

1. AULICKÁ, Zdenka. Regenerace sídlišť. Praha: Výzkumný ústav výstavby a architektury, 1993. ISBN 80-85124-25-4.
2. ČECHOVÁ, Pavla. Potenciál bydlení v panelových domech – možnosti úprav systému T06B v závislostech typologie a konstrukční soustavy. 1. vydání. /
3. Informační příručka pro vlastníky, správce a uživatele panelových bytových domů: technická podpora programu Panel. Praha: Informační centrum ČKAIT, 2002. ISBN 80-86364-94-1.
4. JANOŠKOVÁ, Šárka (ed.). Informační příručka pro vlastníky, správce a uživatele panelových bytových domů. Technická podpora programu PANEL. Praha: Informační centrum ČKAIT, 2002. ISBN 80-86364-94-1.
5. KOHOUT, Michal; TICHÝ, David; TITTL, Filip; KUBÁNKOVÁ, Jana a JAHODOVÁ, Šárka. Sídliště, jak dál? Praha: České vysoké učení technické v Praze, Fakulta architektury, Ústav nauky o budovách, 2016. ISBN 978-80-01-05905-0.
6. KOOLHAAS, Rem. Countryside a Report. 1. vydání. Taschen, 2020. ISBN 978-3-8365-8331-2.
7. LIM, C. J. a LIU, Ed. Smartcities, resilient landscapes and eco-warriors. 2. vydání. London: Routledge, Taylor & Francis Group, 2019. ISBN 978-0-8153-6324-8.
8. NOVÝ, Otakar. KPÚ 25 architektonická bilance. Praha: ?, 1973.
9. SKŘIVÁNKOVÁ, Lucie; ŠVÁCHA, Rostislav; NOVOTNÁ, Eva a JIRKALOVÁ, Karolína (ed.). Paneláci. V Praze: Uměleckoprůmyslové museum, 2016. ISBN 978-80-7101-161-3.
10. SKŘIVÁNKOVÁ, Lucie; ŠVÁCHA, Rostislav; KOUKALOVÁ, Martina a NOVOTNÁ, Eva (ed.). Paneláci 2. V Praze: Uměleckoprůmyslové museum, 2017. ISBN 978-80-7101-169-9.
11. VORLÍK, Petr; GUZIK, Hubert; BERAN, Lukáš; BRŮHOVÁ, Klára; BYKOV, Alex et al. Ambice: architektura osmdesátých let = Ambitions: the architecture of the eighties. Přeložil Robin CASSLING. Praha: České vysoké učení technické v Praze, Fakulta architektury, 2022. ISBN 978-80-01-07028-4.
12. ZADRAŽILOVÁ, Lucie. Když se utopie stane skutečností. Kontexty (Uměleckoprůmyslové museum). V Praze: Uměleckoprůmyslové museum v Praze ve spolupráci s Arbor vitae, 2013. ISBN 978-80-7101-133-0.
13. ZIKMUND-LENDER, Ladislav a CZUMALO, Vladimír. Experimentální sídliště Invalidovna. Hradec Králové: Zikmund, 2014. ISBN 978-80-905-271-3-3.

Online

14. Františkovské sídliště. Liberec v minulosti a současnosti [online]. <https://www.liberecvmnulostiasoucasnosti.cz> [cit. 2024-01-29]. Dostupné z: <https://www.liberecvmnulostiasoucasnosti.cz//kopie-z-liberec-x-frantiskov2/>
15. Konstrukční soustavy panelových domů, vývoj, typy a půdorysy. In: Estav.cz [online]. 2023, 2017-2023 [cit. 2023-11-20]. Dostupné z: <https://www.estav.cz/cz/5773.konstrukcni-soustavy-panelovych-domu-jejich-vyvoj-a-typy-pudorysy>
16. LIPTÁK, Marián a Tomáš PINDEL. PANELÁKY.INFO [online]. 2016 [cit. 2023-11-20]. Dostupné z: <http://panelaky.info>
17. Statistický přehled panelových domů v krajích ČR. In: Tzbinfo [online]. 2023, 2001-2023 [cit. 2023-11-20]. Dostupné z: <https://stavba.tzb-info.cz/regenerace-domu/6323-statisticky-prehled-panelovych-domu-v-krajich-cr>
18. Strategie rozvoje SML 2021+. In: 2021.

Pictures

i Theory-in-Architecture-Athens-Charter-Image-4. In: Re-thinkingthefuture.com [online]. 2022 [cit. 2024-01-14]. Dostupné z: <https://www.re-thinkingthefuture.com/wp-content/uploads/2021/08/A4789-Theory-in-Architecture-Athens-Charter-Image-4.jpeg>

ii Theory-in-Architecture-Athens-Charter-Image-4. In: Re-thinkingthefuture.com [online]. 2022 [cit. 2024-01-14]. Dostupné z: <https://www.re-thinkingthefuture.com/wp-content/uploads/2021/08/A4789-Theory-in-Architecture-Athens-Charter-Image-4.jpeg>

iii Domy pro chudé města Brna. In: Archiweb.cz [online]. 1997, 2024 [cit. 2024-01-14]. Dostupné z: https://cdn.archimedia.eu/cache/images/buildings/gallery/picture_1243_1.jpg-1600x1200-domy-pro-chude-mesta-brna.jpg?algorithm=1&mtime=1642330305

iv Výstavba domů T12 na ulici Zlepšovatelů v roce 1952. In: Ostrava-Jih, po stopách minulosti [online]. 2015, 2016 [cit. 2024-01-14]. Dostupné z: <https://historie.ovajih.cz/wp-content/uploads/2020/02/t12-52.jpg>

v Převzato z: 2. SKŘIVÁNKOVÁ, Lucie; ŠVÁCHA, Rostislav; KOUKALOVÁ, Martina a NOVOTNÁ, Eva (ed.). Paneláci 2. V Praze: Uměleckoprůmyslové museum, 2017. ISBN 978-80-7101-169-9. Str.:155

vi Československý pavilon. Nad strojírenskou expozicí bylo na galerii umístěno oddělení „Odpočinek“, kde si mohli návštěvníci v dutině stylizovaného stromu prohlédnout loutkovou scénu od Jiřího Trnky. In: Ct24. ceskatelevize.cz [online]. 2020 [cit. 2024-01-14]. Dostupné z: https://fs2-ct24.ceskatelevize.cz/image/N2Y5MDBkOTUzYTRhYzFIMnygjrssAqJmzOzA3RznY8pd_DBZviQjcyU55qrEs9NiDqdrIpGXShZoALb8xMpTlqTjpWMQRashgtkk7KECCgplSdIPm212vX2KfLNnor4Ud8KpQZAUqpny-vbRzN11DWCpsZ5W65ouLPlx7VruBC0iqpCFMdRmfmTHEHvX00XFQhBeG5p45y2qdhmQ3qBA.jpg?height=120p

vii Sídliště Králův Háj a v popředí silnice do Vratislavic a budoucí sídliště Broumovská. Fotil jsem kolem roku 1963. (archiv František Zikmund). In: Liberec minulosti a současnosti [online]. 2021 [cit. 2024-01-14]. Dostupné z: <https://32eba348a2.clvaw-cdnwnd.com/b2478adc5e5cc22274c76363082b5ac2/200085331-Off160ff18/3233.webp?ph=32eba348a2>

viii STÁTNI OKRESNÍ ARCHIV ZLÍN. Výstavba panelového domu typu G 40 v letech 1953 až 1954 ve Zlíně Zdroj: https://www.idnes.cz/zlin/zpravy/historie-paneloveho-domu-g40-ve-zline.A150801_2181285_zlin-zpravy_ras. In: IDnes/zpravodajství [online]. 1998, 2024 [cit. 2024-01-14]. Dostupné z: https://www.idnes.cz/zlin/zpravy/historie-paneloveho-domu-g40-ve-zline.A150801_2181285_zlin-zpravy_ras/foto/RAS5d13f2_01VM03A4_B_ZLIN_3562233_CMYK.jpg

ix ARCHÍV NÁRODNÍHO PODNIKU BYTOSTAV. Montáž panelového domu T06B-OS 70 - osazování kompletizovaného obvodového dílce. In: Paneláky.info [online]. 2016 [cit. 2024-01-14]. Dostupné z: <http://panelakyinfo/t06b/>

x ČTK. První nájemníci se stěhovali v roce 1976 a čekala je řada let života v místě bez duše, kde v anonymitě přežívají tisíce vykořeněných lidí. In: IDnes/zpravodajství [online]. 1998, 2024 [cit. 2024-01-14]. Dostupné z: https://1gr.cz/fotky/idnes/21/093/cl5/LUH8e3767_F200911201685101.jpeg

xi BERVIDA, Jiří. Výtvarně pojaté fasády na plzeňských panelácích. In: IDnes/zpravodajství [online]. 2010 [cit. 2024-01-14]. Dostupné z: https://1gr.cz/fotky/idnes/10/101/cl6/ALT365661_151048_4412504.jpg

xii BARTOVSKÝ, Ota. Beruška na panelovém domu na sídlišti Rochlice. In: IDnes/zpravodajství [online]. 2017 [cit. 2024-01-14]. Dostupné z: https://1gr.cz/fotky/idnes/17/011/cl5/JAP686dc4_penelovdmpanelk_2.jpg

xiii Sídliště máj. In: CBArchitektura [online]. 2012 [cit. 2024-01-14]. Dostupné z: <http://3.bp.blogspot.com/-8uZGu3vv5dQ/Ty1WQ6QdCNI/AAAAAAAAAaE/yia7SkKkKew/s1600/4.jpg>

xiv KUČERA, Jakub. Sídliště mění svoji podobu do duhových barev. In: Čti doma [online]. 2019 [cit. 2024-01-14]. Dostupné z: https://www.ctidoma.cz/sites/default/files/styles/image_detail/public/imgs/31/55661524_826771074339800_7449914924337201152_o.jpg

xv ARCHIV KGVUZ. Panelový dům G55 (1955). In: Zlínský architektonický manuál [online]. 2024 [cit. 2024-01-19]. Dostupné z: https://zam.zlin.eu/data/photo/thumb/651_8a8bd23e66.jpg?1583517378

xvi Havířovský zpravodaj o historii města. Facebook [historické zpravodajství, typ příspěvku: fotografie]. 12. 08 2018, 22:45 [cit. 2024-01-14]. Dostupné z: <https://www.facebook.com/Kamil.Krenek.1975/posts/pfbid02dXe1ev37JvZFcpeg5kKTYrhZYLpFDH1fqMXiK29HMhoSD3jXBcbp7eT2jpDUMofpl>

xvii Larsen Nielsen. In: Estav [online]. 2018 [cit. 2024-01-19]. Dostupné z: https://www.estav.cz/img/_/5773.foto/tn/larsennielsen.jpg?1514982711

xviii Panelové domy BP70-OS-R na Jugoslávské ulici v Zábřehu. In: Ostrava jih - po stopách minulosti [online]. 2015, 2016 [cit. 2024-01-19]. Dostupné z: <https://historie.ovajih.cz/wp-content/uploads/2019/04/DSCN5878-768x576.jpg>

xix Je to skoro čtyřicet let, kdy si první obyvatelé Jižního města vyzvedli dekret na byt. In: R plus [online]. 2015 [cit. 2024-01-19]. Dostupné z: <https://plus.rozhlas.cz/sites/default/files/images/03467578.jpeg>

xx Author's photo

xxi SALAČ, Jan. Současná podoba paneláku na zlínském Benešově nábřeží, číslo popisné 3828. Autor: Jan Salač, MAFRA. In: IDnes [online]. 2015 [cit. 2024-01-19]. Dostupné z: https://1gr.cz/fotky/idnes/15/081/vidw/RAS5d13f7_01VM03C2_ZLIN_3564687_CMYK.jpg

xxii Poznávacím prvkem jsou neobvykle pojaté lodžie. In: Paneláky.info [online]. 2016 [cit. 2024-01-19]. Dostupné z: https://panelakyinfo/wp-content/uploads/2016/03/DSC_0947-300x200.jpg

xxiii Pražské Jižní město. In: Novinky.cz [online]. 2018 [cit. 2024-01-19]. Dostupné z: https://d15-a.sdn.cz/d_15/c_img_E_F/zluGdF.jpeg?fl=cro,0,146,800,450%7Cres,722,,1%7Cjpg,80,,1

xxiv Bytové domy na sídlišti Ďáblice. In: CAMP Praha [online]. 2022 [cit. 2024-01-19]. Dostupné z: <https://praha.camp/img/cache/1440/7831377a11d7271b47fbda1d5eadf0218c35a29c6a93cbdd20485c1163c73e0a>

xxv Výškovice, Lumírova ulice a blok, který ze všech stran vypadá jako hokejka. AMO. In: Ostrava jih - po stopách minulosti [online]. 2015, 2016 [cit. 2024-01-19]. Dostupné z: <https://historie.ovajih.cz/wp-content/uploads/2018/05/Lumirova-768x568.jpg>

xxvi Františkov. Foto Jan Kabiček, z knihy Liberec, Severočeské nakladatelství Ústí nad Labem, 1977 (archiv Liberec 1945 - 1990). In: Liberec v minulosti a současnosti [online]. 2021 [cit. 2024-01-19]. Dostupné z: <https://32eba348a2.clvaw-cdnwnd.com/b2478adc5e5cc22274c76363082b5ac2/200061752-003f8003f9/Františkov.%20Foto%20Jan%20Kabiček%2C%20z%20knihy%20Liberec%2C%20Severočeské%20nakladatelství%20Ústí%20nad%20Labem%2C%201977.webp?ph=32eba348a2>

xxvii Apolitické téma Kluka s písňalkou si pro sochu před gymnáziem Františka Křížka vybral Zdeněk Jílek. Snímek z roku 1981. In: IDnes [online]. 2016 [cit. 2024-01-19]. Dostupné z: https://1gr.cz/fotky/idnes/16/113/p135/PP678dbb_164225_2411973.jpg

xxviii Author's photo

xxix NĚMEC, Ladislav. Během normalizace vznikly v Plzni na Lochotíně tisíce bytů. In: IDnes [online]. 2021 [cit. 2024-01-19]. Dostupné z: https://1gr.cz/fotky/idnes/16/113/p135/PP678b59_loch2.jpg

xxx Výškovice, Lumírova ulice a blok, který ze všech stran vypadá jako hokejka. AMO. In: Ostrava jih - po stopách minulosti [online]. 2015, 2016 [cit. 2024-01-19]. Dostupné z: <https://historie.ovajih.cz/wp-content/uploads/2018/05/Lumirova-768x568.jpg>

xxxi VRABEC, Jan. Švermova ulice z viaduktu. In: Liberecký Deník [online]. 2008 [cit. 2024-01-25]. Dostupné z: https://liberecky.denik.cz/galerie/foto.html?mm=dsc_0976_frantiskov&back=4218775754-1119-25&photo=1

xxxii Construction archive of the statutory city of Liberec

xxxiii Author's photo

xxxiv Author's photo

xxxv Schema. In: Lacaton & Vassal [online]. 2024 [cit. 2024-01-25]. Dostupné z: <http://www.lacatonvassal.com/data/images/icon/20111219-231844-z191.jpg>

xxxvi Transformation of 530 dwellings. In: Arch Daily [online]. 2016 [cit. 2024-01-25]. Dostupné z: [https://www.archdaily.com/915431/transformation-of-530-dwellings-lacaton-and-vassal-plus-frederic-druot-plus-christophe-hutin-architecture-photo](https://www.archdaily.com/915431/transformation-of-530-dwellings-lacaton-and-vassal-plus-frederic-druot-plus-christophe-hutin-architecture/5cb89409284dd1a8120000c1-transformation-of-530-dwellings-lacaton-and-vassal-plus-frederic-druot-plus-christophe-hutin-architecture-photo)

xxxvii Holiš + Šochová architekti - Revitalizace panelového domu v Rožnově. Katalog.Earch.cz [online]. 2021 [cit. 2024-01-21]. Dostupné z: <https://www.earch.cz/storage/images/b5/b562391c-d659-4b27-87db-a1784a3d455f.full.jpg>

xxxviii Holiš + Šochová architekti - Revitalizace panelového domu v Rožnově. Katalog.Earch.cz [online]. 2021 [cit. 2024-01-21]. Dostupné z: <https://www.earch.cz/storage/images/b5/b562391c-d659-4b27-87db-a1784a3d455f.full.jpg>

xxxix Hostivar_panelak_005. In: Re:architekti [online]. 2024 [cit. 2024-01-22]. Dostupné z: https://rearchitekti.cz/wp-content/uploads/2023/10/Hostivar-panelak_005_foto_Ondrej_Bouska-1536x1024-1-1280x853.jpg

xl Hostivar_panelak_005. In: Re:architekti [online]. 2024 [cit. 2024-01-22]. Dostupné z: https://rearchitekti.cz/wp-content/uploads/2023/10/Hostivar-panelak_005_foto_Ondrej_Bouska-1536x1024-1-1280x853.jpg

xli Zelena-strecha-na-panelovem-dome2. In: Green Top [online]. [cit. 2024-01-22]. Dostupné z: <https://www.greentop.cz/wp-content/uploads/2021/02/zelena-strecha-na-panelovem-dome2-1024x682.jpg>

xliv Green Roof on a Block of Flats in Brno. In: Adaptterra Awards [online]. 2024 [cit. 2024-01-22]. Dostupné z: https://www.adaptterraawards.cz/getattachment/Databaze/2022/Zelena-strecha-na-panelovem-dome-Brno/220630_13_brno-bohunice_04.jpg?width=1200&height=800

xliii Green Roof on a Block of Flats in Brno. In: Adaptterra Awards [online]. 2024 [cit. 2024-01-22]. Dostupné z: https://www.adaptterraawards.cz/getattachment/Databaze/2022/Zelena-strecha-na-panelovem-dome-Brno/220630_13_brno-bohunice_04.jpg?width=1200&height=800

xlv Rok po realizaci_05. In: GreenVille [online]. 2024 [cit. 2024-01-22]. Dostupné z: https://www.greenville.cz/uploads/1/1/6/6/11668741/img-8957_orig.jpg

xlvi DRUOT, Frédéric. Transformation de la Tour Bois le Prêtre. In: Lacaton & Vassal [online]. 2024 [cit. 2024-01-25]. Dostupné z: <http://www.lacatonvassal.com/data/images/icon/20140507-204539-z265.jpg>

xlvii Schema. In: Lacaton & Vassal [online]. 2024 [cit. 2024-01-25]. Dostupné z: <http://www.lacatonvassal.com/data/images/icon/20111219-231844-z191.jpg>

xlviii Solhus 3. In: NORDSTRÖM KELLY ARKITEKTER [online]. 2024 [cit. 2024-01-22]. Dostupné z: https://res.cloudinary.com/allyou/image/upload/v1/3/35482/images/3853163/Solhus_3_tqipt

xlix Gutgut, Panelák v Rimavskej Sobote - foto. In: Earch.cz [online]. 2021, 2023 [cit. 2024-01-21]. Dostupné z: <https://www.earch.cz/storage/images/83/83ceb966-ff9b-4ab3-b8c0-526387ea0068.full.jpg>

l Solhus 2. In: NORDSTRÖM KELLY ARKITEKTER [online]. 2024 [cit. 2024-01-22]. Dostupné z: https://res.cloudinary.com/allyou/image/upload/v1/3/35482/images/3853087/2_Solhusen_2_ag9zwt

li Solhus 3. In: NORDSTRÖM KELLY ARKITEKTER [online]. 2024 [cit. 2024-01-22]. Dostupné z: https://res.cloudinary.com/allyou/image/upload/v1/3/35482/images/3853163/Solhus_3_tqiptp

lii RDTH-architekti-projekt-Byt-12-metru-dlouhy-12. In: RDTH [online]. 2024 [cit. 2024-01-22]. Dostupné z: <https://rdth.cz/wp-content/uploads/2022/09/RDTH-architekti-projekt-Byt-12-metru-dlouhy-12.jp>

liii RRTH-architekti-projekt-Byt-12-metru-dlouhy-9. In: RDTH [online]. 2024 [cit. 2024-01-22]. Dostupné z: <https://rdth.cz/wp-content/uploads/2022/09/RDTH-architekti-projekt-Byt-12-metru-dlouhy-9.jpg>

liiii Patterned doormats have also been introduced. In: Dezeen [online]. 2022 [cit. 2024-01-22]. Dostupné z: https://static.dezeen.com/uploads/2022/12/park-hill-estate-phase-2-mikhail-riches-architecture-residential-housing-renovations_dezeen_2364_col_11-852x639.jpg

liv The original concrete details are left exposed. In: Dezeen [online]. 2022 [cit. 2024-01-22]. Dostupné z: https://static.dezeen.com/uploads/2022/12/park-hill-estate-phase-2-mikhail-riches-architecture-residential-housing-renovations_dezeen_2364_col_7-scaled.jpg

lv Voorzijde-enschedelaan. In: Vanschagen architecten [online]. 2024 [cit. 2024-01-22]. Dostupné z: <https://www.vanschagenarchitecten.nl/wp-content/uploads/2019/01/1100-Voorzijde-enschedelaan-nieuwe-situatie.jpg>

lvi Patterned doormats have also been introduced. In: Dezeen [online]. 2022 [cit. 2024-01-22]. Dostupné z: https://static.dezeen.com/uploads/2022/12/park-hill-estate-phase-2-mikhail-riches-architecture-residential-housing-renovations_dezeen_2364_col_11-852x639.jpg

lvii Google Streetwiev

lviii Google Streetwiev

lix Hnízdo. In: Tvary [online]. 2024 [cit. 2024-01-22]. Dostupné z: https://res.cloudinary.com/tvary/w_1366%2Cc_fill%2Cq_auto:eco%2Cf_auto/auto-mapping/kor-dsc01236-vlastni.jpg

lx Hnízdo. In: Tvary [online]. 2024 [cit. 2024-01-22]. Dostupné z: <https://tvary.net/wp-content/uploads/kor-dsc01288-vlastni.jpg>

lxi Švermova Františkov. In: Liberec v minulosti a současnosti [online]. 2021 [cit. 2024-01-29]. Dostupné z: <https://32eba348a2.clvaw-cdnwnd.com/b2478adc5e5cc22274c76363082b5ac2/200061734-8af218af23/LBC%20-%20Františkov%2C%20atobusové%20nádraží%20%281%29.webp?ph=32eba348a2>

lxii Transformation of 530 dwellings. In: Arch Daily [online]. 2016 [cit. 2024-01-25]. Dostupné z: <https://www.archdaily.com/915431/transformation-of-530-dwellings-lacaton-and-vassal-plus-frederic-druot-plus-christophe-hutin-architecture/5cb8942e284dd1144700015e-transformation-of-530-dwellings-lacaton-and-vassal-plus-frederic-druot-plus-christophe-hutin-architecture-photo>

lxiii Transformation of 530 dwellings. In: Arch Daily [online]. 2016 [cit. 2024-01-25]. Dostupné z: <https://www.archdaily.com/915431/transformation-of-530-dwellings-lacaton-and-vassal-plus-frederic-druot-plus-christophe-hutin-architecture/5cb89409284dd1a8120000c1-transformation-of-530-dwellings-lacaton-and-vassal-plus-frederic-druot-plus-christophe-hutin-architecture-photo>

lxiv Transformation of 530 dwellings. In: Arch Daily [online]. 2016 [cit. 2024-01-25]. Dostupné z: <https://www.archdaily.com/915431/transformation-of-530-dwellings-lacaton-and-vassal-plus-frederic-druot-plus-christophe-hutin-architecture/5cb89409284dd1a8120000c1-transformation-of-530-dwellings-lacaton-and-vassal-plus-frederic-druot-plus-christophe-hutin-architecture-photo>

Františkov Hřiště. In: Františkovská škola [online]. 2021 [cit. 2024-01-30]. Dostupné z: <https://32eba348a2.clvaw-cdnwnd.com/b2478adc5e5cc22274c76363082b5ac2/200080687-933cc933ce/2430.webp?ph=32eba348a2>

lxv KŘÍŽ, A. Sídliště Františkov v 70. letech. In: Liberec v minulosti a současnosti [online]. 2021 [cit. 2024-01-25]. Dostupné z: https://32eba348a2.clvaw-cdnwnd.com/b2478adc5e5cc22274c76363082b5ac2/200061741-2507525077/97984339_3603535586328451_5841453146613743616_n-0.webp?ph=32eba348a2

ČESKÉ VYSOKÉ UČENÍ TECHNICKÉ V PRAZE
FAKULTA ARCHITEKTURY

AUTOR, DIPLOMANT: Eliška Kořínková
AR 2023/2024, LS

NÁZEV DIPLOMOVÉ PRÁCE:
(ČJ) T06B

(AJ) T06B

JAZYK PRÁCE: ANGLIČTINA

Vedoucí práce: Doc. Ing. arch. Dalibor Hlaváček, Ph.D. Ústav: Ústav Navrhování II

Oponent práce: Jakob Dunkl

Klíčová slova
(česká): prefabrikovaný panelový dům, revitalizace, bydlení

Anotace
(česká): Předmětem této diplomové práce je analýza, zhodnocení a návrh možných vstupů do panelové soustavy T06B. Práce se zabývá historickým kontextem, posouzením kladných a problematických aspektů panelové soustavy a návrhem systémových řešení rozdělených do samostatných podkategorií. Navržená řešení jsou následně aplikována na konkrétní dům soustavy T06B v Liberci na sídlišti Františkov.

Anotace
(anglická): The subject of this diploma thesis is the analysis, evaluation, and proposal of possible interventions to the T06B panel system. The work addresses the historical context, assesses the positive and problematic aspects of the panel system, and proposes systematic solutions divided into separate subcategories. The proposed solutions are subsequently applied to a specific T06B building in the Františkov housing estate in Liberec.

Prohlášení autora

Prohlašuji, že jsem předloženou diplomovou práci vypracoval samostatně a že jsem uvedl veškeré použité informační zdroje v souladu s „Metodickým pokynem o etické přípravě vysokoškolských závěrečných prací.“

V Praze dne 23.5.24

podpis autora/diplomanta

Tento dokument je nedílnou a povinnou součástí diplomové práce / portfolia a CD.

České vysoké učení technické v Praze, Fakulta architektury

2/ ZADÁNÍ diplomové práce

Mgr. program navazující

jméno a příjmení: Eliška Kořínková

datum narození: 08.01.1999

akademický rok / semestr: 2023/2024 / LS

obor: Architektura a urbanismus

ústav: 15128 Ústav navrhování II

vedoucí diplomové práce: doc. Ing. arch. Dalibor Hlaváček, Ph.D.

téma diplomové práce: Soustava T08B – včera, dnes a zítra

viz přihláška na DP

zadání diplomové práce:

1/ popis zadání projektu a očekávaného cíle řešení
Zadání diplomové práce vychází z diplomního semináře. Tématem diplomové práce je návrh možností transformace objektů panelové soustavy T06B. Provéření možností úprav objektů vzhledem k soudobým požadavkům na bydlení a jejich aplikace na konkrétní bytový panelový dům soustavy T06B v Liberci na sídlišti Františkov. Cílem je úvaha o výhodách panelové soustavy a jejich využití při řešení současných problémů konstrukce a dispozic konkrétního bytového domu.

2/ Pro AU/ součástí zadání bude jasně a konkrétně specifikovaný stavební program
Transformace stávající bytové stavby by měla nabídnout nové varianty řešení bytových jednotek, možnosti využití prostorů bývalých prádeln, sušáren, případně ploché střechy a možnosti zlepšení tepelně technických vlastností budovy. Součástí zadání je také ověření efektivnějšího propojení stávajícího objektu s okolím a možnosti navržení případných nových funkcí veřejného či soukromého vybavení.
Stavební program může být upraven dle dohody s vedoucím DP.

3/ popis závěrečného výsledku, výstupy a měřítka zpracování
Odevzdány budou postery v rozsahu dle požadavků FA ČVUT a 2 portfolia (jedno pro účel FA, jedno bude archivováno na ústavu). Diplomová práce bude zveřejněna dle požadavků studijního oddělení FA.

Bude zpracováno urbanistické řešení vč. návaznosti na okolí a řešení veřejného prostoru, podrobně navrhovaná budova pak na úrovni detailní studie. Součástí projektu bude:

analytická, textová část a koncepční část

- autorský text; analytická část; koncept řešení znázorněný pomocí schémat urbanistické řešení

- situace širších vztahů 1:2500; urbanistické řešení prezentované na situacích, řezech a pohledech 1:500, axonometrii a celkových vizualizacích

vybraná část na úrovni detailní studie

- půdorysy typických podlaží 1:200; typické řezy (příp. perspektivní řezy) včetně návaznosti na nejbližší okolí 1:200; pohledy; návrh interiéru zvoleného prostoru nebo interiéru veřejného prostoru; principy technického a konstrukčního řešení, principy udržitelnosti, detail (řez, pohled) vybraného segmentu fasády 1:20; vizualizace (exteriér, interiéru, příp. zákresy do fotografie) dostatečně vysvětlující návrh (nejméně 7 pohledů).

Součástí projektu mohou být i další výstupy potřebné pro prezentaci návrhu. Výstupy a jejich měřítka mohou být vzhledem k vývoji práce upraveny dle dohody s vedoucím DP.

4/ seznam dalších dohodnutých částí projektu (model)

Model v min. měřítku 1:200 včetně nejbližšího okolí.

12. 02. 2024
Datum a podpis studenta

Datum a podpis vedoucího DP

Datum a podpis děkana FA ČVUT

registrováno studijním oddělením dne

15/2/24 Kruš

In conclusion, I would like to express my gratitude to my thesis advisor, Dalibor Hlaváček, and the assistant professors, Martin Čeňek and Tomáš Minarovič, for their optimism, valuable advice, and the time they dedicated to our consultations.

I am thankful to my family and loved ones for their support, patience, and perspective.

Lastly, I would like to thank my friends, especially those who have walked this path alongside me.

